

RCA

USER'S GUIDE

multimediamonitormultimedia
monitormultimediamonitormul
timediamonitormultimediamon
itormultimediamonitormultim
ediamonitormultimediamonito
rmultimediamonitormultimedi
amonitormultimediamonitormu
ltimediamonitormultimediamo
nitormultimediamonitormulti
mediamonitormultimediamonit
ormultimediamonitormultimed
iamonitormultimediamonitorm
ultimediamonitormultimediam
onitormultimediamonitormult
imediamonitormultimediamoni
tormultimediamonitormultime
diamonitormultimediamonitor
multimediamonitormultimedia
monitormultimediamonitormul
timediamonitormultimediamon
itormultimediamonitormultim
ediamonitormultimediamonito
rmultimediamonitormultimedi
amonitormultimediamonitormu
ltimediamonitormultimediamo
nitormultime diamon
itormultime dia
monitormu It
imediam on
itorm ulti
media mo
nitorm ul
timedi a
monit o
rmulti



IMPORTANT INFORMATION

WARNING

To reduce the risk of fire or shock hazard, do not expose this TV to rain or moisture.

WARNING

RISK OF ELECTRIC SHOCK DO NOT OPEN

To reduce the risk of electric shock, do not remove cover (or back). No user serviceable parts inside. Refer servicing to qualified service personnel.



This symbol indicates "dangerous voltage" inside the product that presents a risk of electric shock or personal injury.



This symbol indicates important instructions accompanying the product.

Refer to the identification/rating label located on the back panel of your product for its proper operating voltage.

FCC Regulations state that unauthorized changes or modifications to this equipment may void the user's authority to operate it.

If fixed (non-moving) images are left on the screen for long periods, they may be permanently imprinted on the screen. Such images include network logos, phone numbers, and video games. This damage is not covered by your warranty. Extended viewing of channels displaying these images should be avoided.

Cable TV Installer: This reminder is provided to call your attention to Article 820-40 of the National Electrical Code (Section 54 of the Canadian Electrical Code, Part 1) which provides guidelines for proper grounding and, in particular, specifies that the cable ground shall be connected to the grounding system of the building as close to the point of cable entry as practical.

PRODUCT REGISTRATION

Please fill out the product registration card and return it immediately. Returning the card allows us to contact you if needed.

Keep your sales receipt to obtain warranty parts and service and for proof of purchase. Attach it here and record the serial and model numbers in case you need them. The numbers are located on the back of the player.

Model No. _____

Serial No. _____

Purchase Date: _____

Dealer/Address/Phone: _____

TABLE OF CONTENTS

Connections & Setup	5
Connecting Components to your Monitor	6
Antenna/Cable In	6
Audio/Video/S-Video Inputs (Input1, Input2, Input3)	7
Audio/Component Video Inputs	8
Selected Video Outputs	8
Audio Output	9
Optional Component Connection Examples	10
Monitor and a VCR.....	10
Viewing the VCR Input Channel	10
Monitor, VCR and a Satellite Receiver	11
Viewing the Components	11
Monitor, VCR, Satellite Receiver, and a DVD Player	12
Viewing the Components	12
A/V Receiver & Speakers	13
(S)VGA Video Inputs –(S)VGA1, (S)VGA2	14
(S)VGA1 Input Connection Examples	15
Viewing the (S)VGA1 Input.....	15
(S)VGA2 Input Connection Example.....	16
Viewing the (S)VGA2 Input.....	16
Front Inputs	17
USB Inputs/Output	17
Setting Up the Monitor	18

TABLE OF CONTENTS

First Time Set Up	18
The Point and Select Navigation Method	19
Set the Time	19
Auto Channel Search	20
Set the VCR1 Channel (auto tuning)	21
Set the VCR2 Channel (auto tuning)	22
Set the DVD Channel (auto tuning)	23
Set the SAT/CABLE Channel (auto tuning)	24
Label the Channels	25
What Now?	25
Using the Remote	27
Remote Buttons	28
Using the INPUT button	29
Programming the Remote	29
Testing the Remote	29
Programming the Remote	30
Using Automatic Code Search	30
Using Direct Entry	30
Using the remote to control a device	31
Modes of Operation	31
Front Panel	31
Remote Control Codes	32
Menus and features	33
Menus and Control Panels	34
Menus	34
Exiting a Menu	34

TABLE OF CONTENTS

Control Panels	35
Sliders	35
Numeric Entry	35
Choice Lists.....	36
Audio Menu	36
Picture Quality Menu	37
Screen Menu	38
Closed-Captioning	38
Channel Menu	39
Time Menu	40
Parental Controls and V-Chip	41
V-Chip TV Rating Limit	42
The Ratings Limits Screen	42
Blocking Age-based Ratings	43
Viewing Age-based Ratings	44
Blocking Specific Content Themes	44
Viewing Specific Content Themes	45
V-Chip Movie Rating Limit	46
Blocking Movie Ratings.....	46
Viewing Movie Ratings	46
V-Chip Unrated Program Block	47
Channel Block	47
Front Panel Block	47
Lock/Unlock Parental Controls	47
PIP (Picture-in-Picture) Operation	48
PIP Buttons	48
Using the PIP Feature	48
Channel Marker	49

TABLE OF CONTENTS

Reference	51
RCA MultiMedia Monitor Specifications	52
Troubleshooting	53
Monitor will not turn on	53
Controls don't work	53
Problems with Remote	53
Blank screen	53
Picture on screen is not centered	53
Horizontal or diagonal lines on screen	53
Black Box appears on the screen	53
No sound, picture okay	54
Can't select certain channel	54
Turns off while playing	54
Noisy stereo reception	54
No picture, no sound but TV is on	54
Sound okay, picture poor	54
Care and Cleaning	54
RCA MultiMedia Monitor Limited Warranty	55
Radio Interference	59
Index	60

CONNECTIONS & SETUP

GETTING STARTED

This manual is designed to get you started quickly. The first two sections of the manual show you how to:

- Get your monitor set up and connected,
- Set up your monitor
- Program the remote

The remaining sections discuss the menus and features, and include a Reference section which contains troubleshooting tips, care and cleaning instructions, accessory ordering information and your warranty.

1 CONNECTIONS & SETUP



2 USING THE REMOTE



3 MENUS AND FEATURES



4 REFERENCE

Check out the notes that have been added throughout the manual in these Tip Boxes. There are some important tips that will help you get the most from your monitor.

CONNECTIONS & SETUP

CONNECTING COMPONENTS TO YOUR MONITOR

Your monitor has several input and output jacks that you can use with many different types of components. This creates a great number of connection variations. Therefore, the following section shows the different types of jacks and examples of the types of components that can be connected to those jacks. Before you begin, it's a good idea to read any connection information in other components' user manuals as well.

Before You Connect

Protect against power surges:

- Connect all components before plugging any power cords into the wall outlet.
- Turn off the monitor and/or component before connecting or disconnecting any cables.
- Make sure all antennas and cables are properly grounded. Refer to the "Important Safeguards" sheet packed with your monitor.

ANTENNA/CABLE IN

The ANTENNA/CABLE IN jack lets you connect a screw-on or push on antenna or cable lead. Use this if you want the monitor to receive signals through a coaxial cable from an antenna or other source, such as a VCR.

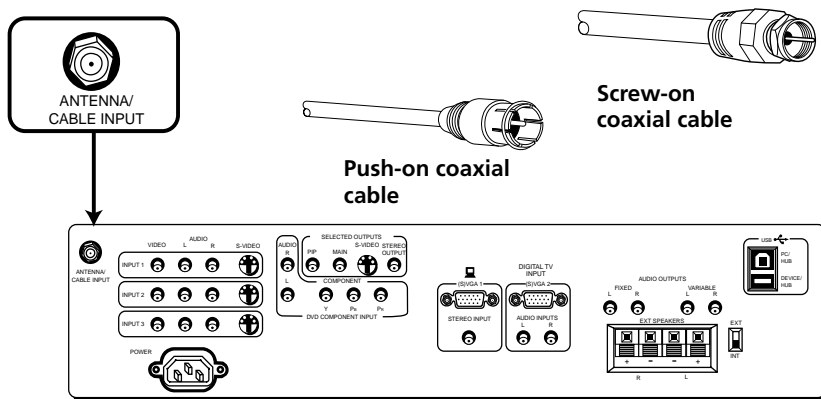

You can use coaxial cables to connect devices such as:

- Antenna or cable leads
- Cable boxes
- VCRs
- Satellite receivers

CONNECTIONS & SETUP

AUDIO/VIDEO/S-VIDEO INPUTS

(INPUT1, INPUT2, INPUT3)

The audio jacks provide stereo sound. If your device has only one audio output, you need to connect a "Y" adapter to your component and to both the left and right inputs on the monitor.

The video jack provides better picture quality than coaxial cable, because it carries only video signals.

If your device has S-video output, use an S-Video cable to connect the video jacks. This method separates the video signals into two separate signals: one for color, the other for brightness. This helps prevent the signal from degrading and results in a sharper image.

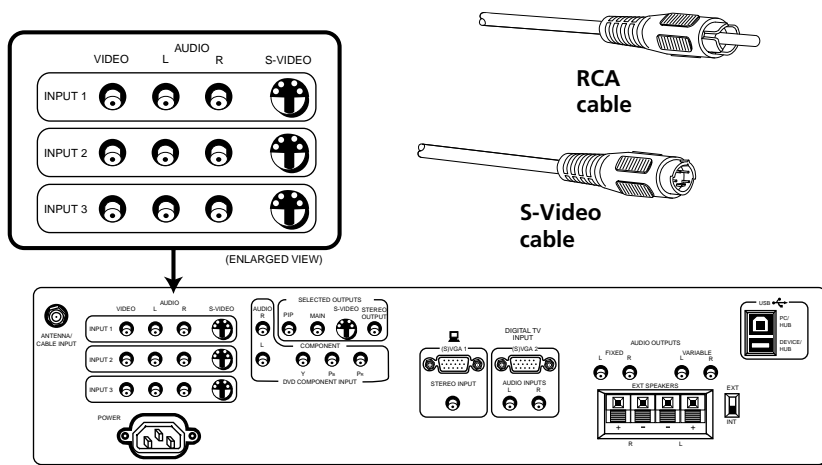

You can use audio/video and s-video jacks to connect devices such as:

- VCRs
- Satellite receivers
- DVD players
- Laserdisc players
- Camcorders
- Internet devices

To View the Video Inputs...

First, press the TV button on the remote to make sure that the remote is in TV mode; then press the INPUT button to scroll through the video inputs.

CONNECTIONS & SETUP

SELECTED VIDEO OUTPUTS

Provides audio and video output from the monitor tuner.

PIP provides video output for the picture-in-picture window. Note that audio is not available with the PIP output.

MAIN provides video output for the main picture window.

S-Video provides s-video output for the main picture.

Stereo Output provides stereo audio through a 3.5 mm stereo mini-jack.

In PC Mode...

In PC mode, the last selected source (for the selected output) appears. Basically, whatever you were watching on INPUT 1, 2, 3, or the tuner channel.

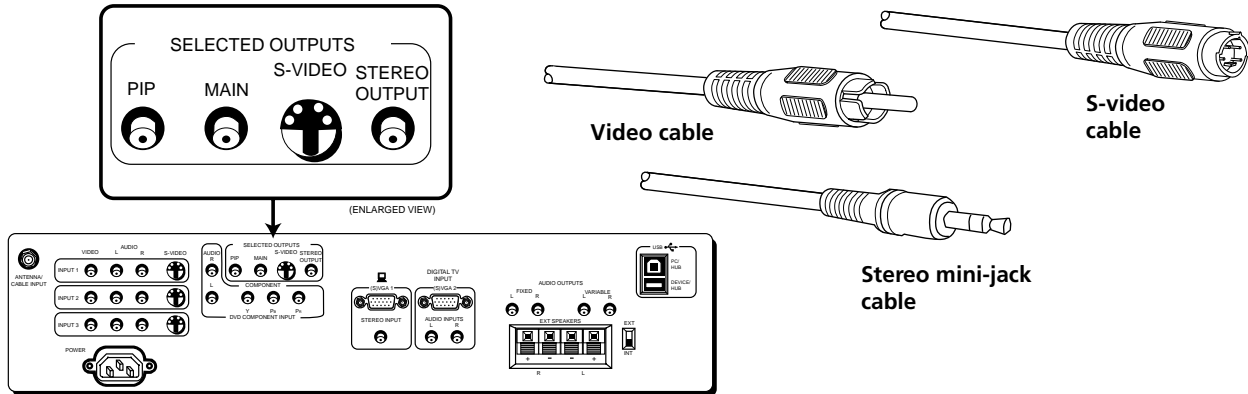

You can use selected video output jacks to connect devices such as:

- compatible A/V receivers
- compatible recording equipment
- PC with a compatible graphics card

AUDIO/COMPONENT VIDEO INPUTS

These jacks let you connect a compatible DVD player. Unlike a single video input, component video maintains the video signal as three separate signals. The component video connection provides optimum quality. The audio jacks provide stereo sound. **It is essential to match the color coded connectors between a compatible DVD player and the monitor.**

Component Video Tip

To ensure maximum picture quality, use three video-grade cables for the Y, Pb, and Pr connections.

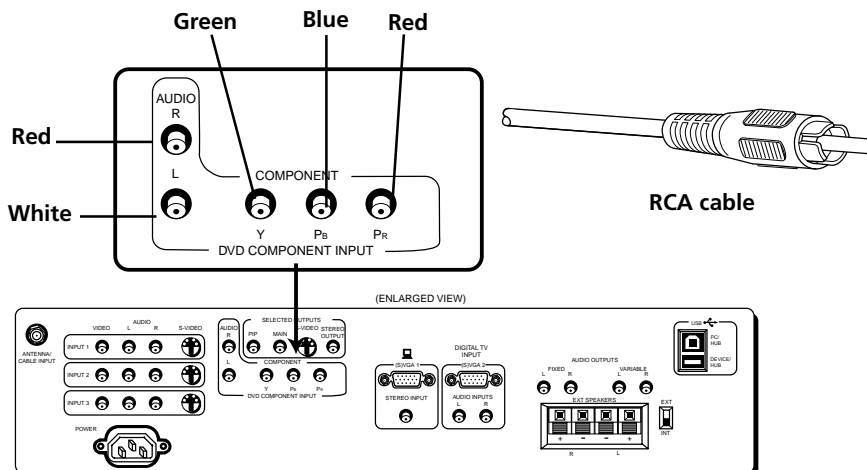

To View the DVD Component Input...

First, press the TV button on the remote to make sure that the remote is in TV mode; then press the INPUT button to scroll through the video inputs.

CONNECTIONS & SETUP

AUDIO OUTPUT

FIXED provides fixed-level audio output from the monitor. This audio output is ideal for connecting to an A/V receiver when you want to control the volume through the A/V receiver.

VARIABLE provides variable-level audio output. Volume levels are controlled by the volume controls on the monitor and monitor remote control.

EXT SPEAKERS lets you connect external left and right speakers to the monitor. The EXT/INT switch beside the jacks let you turn the monitor's internal speakers on or off. EXT sends audio to external speakers. INT sends audio only to the monitor's internal speakers.

Audio Output Tips

- You may want to adjust the monitor's tone control and audio processor settings to enhance the audio output when connecting an A/V receiver to the Variable output jacks.
- You can turn off the monitor's internal speakers by using the "Speaker" control in the Audio menu. (See the "Audio Menu" section for more information.)

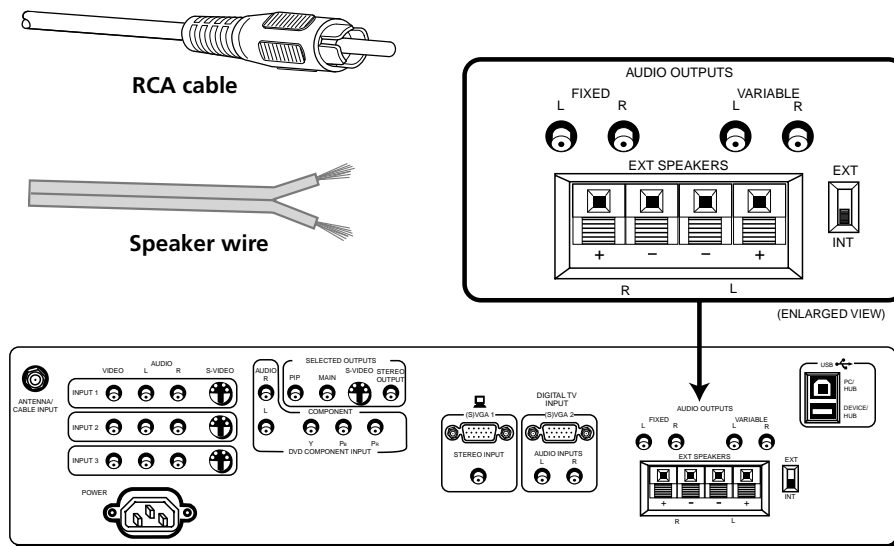

You can use audio output jacks to connect devices such as:

- Audio/video receiver
- Audio amplifier
- Optional external speakers

External Speaker Rating

The external speaker rating is 8 ohms with 10 watts power handling capabilities.

CONNECTIONS & SETUP

OPTIONAL COMPONENT CONNECTION

EXAMPLES

The following examples feature some of the optional components you can connect to your monitor. Refer to the preceding pages for the types of cables used for each connection.

Monitor and a VCR

1. Connect the coaxial cable carrying your television signal (off air or cable) to the antenna input on the VCR.
2. Connect a coaxial cable to the VCR's antenna output and to the ANTENNA/CABLE INPUT jack on the monitor.
3. Use RCA cables to connect the VCR's audio/video output to the INPUT 1 input on the monitor.

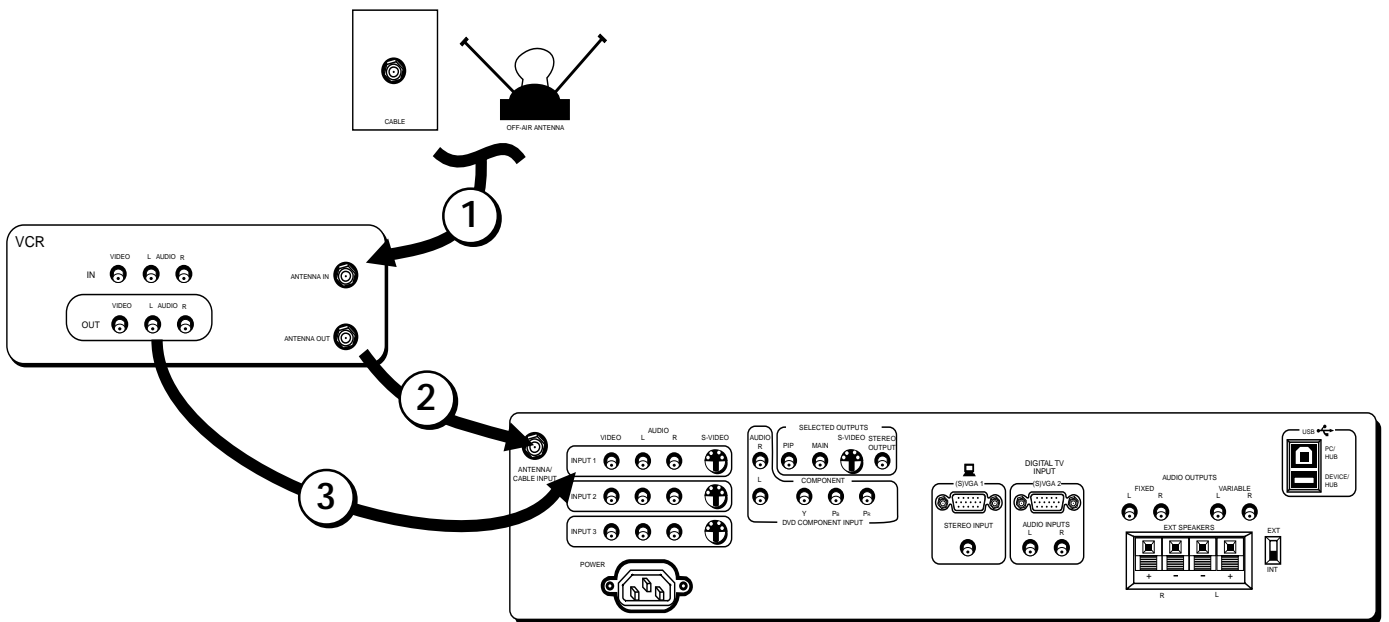

Viewing the VCR Input Channel

1. Turn on the monitor and the VCR.
2. Press the TV button on the remote control.
3. Press INPUT on the remote to scroll through the video inputs.

Direct Channel Tuning

You can set up the monitor to automatically tune to the VCR input. This is called auto tuning. (See "Setup" for more information.)

CONNECTIONS & SETUP

Monitor, VCR, and a Satellite Receiver

1. Connect the coaxial cable carrying your television signal (off air or cable) to the antenna input on the VCR.
2. Connect a coaxial cable to the VCR's antenna output and to the ANTENNA/CABLE INPUT jack on the monitor.
3. Use RCA cables to connect the VCR's audio/video output to INPUT 1 on the monitor.
4. Use RCA cables to connect the satellite receiver's audio/video output to the INPUT 2 input on the monitor. If your satellite receiver has an S-Video output, you can make the video connection by using the S-Video jacks instead.

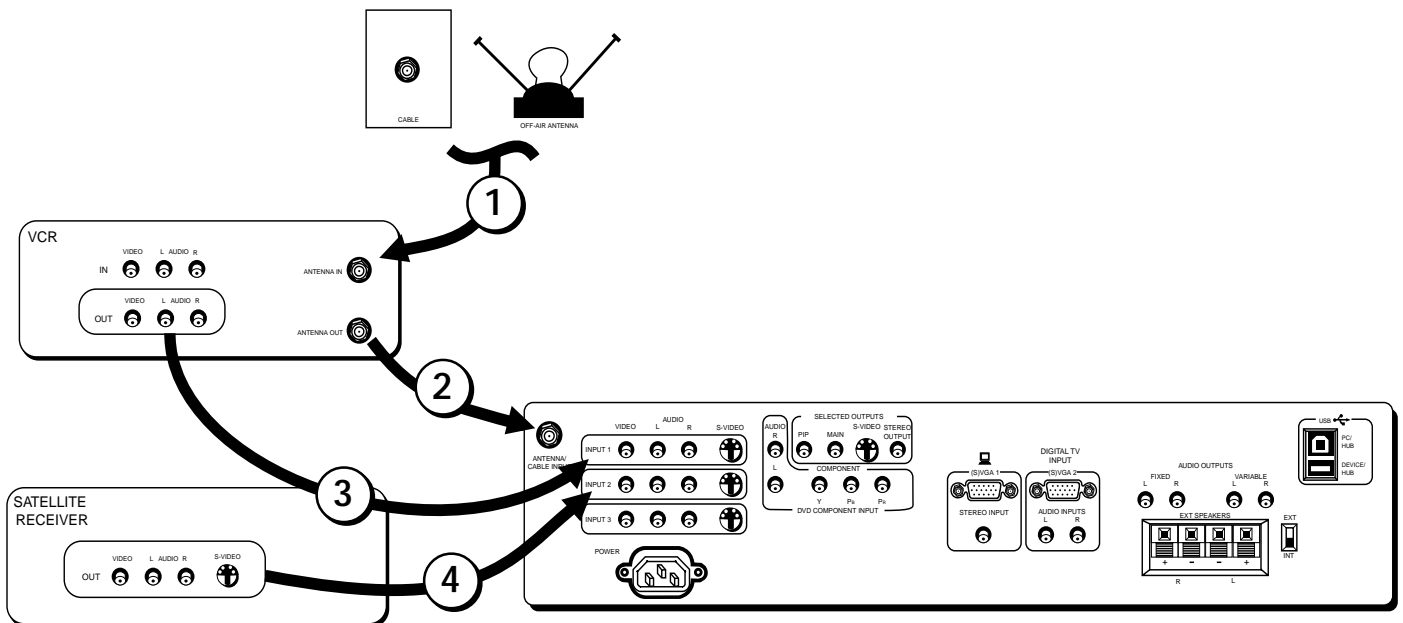

Viewing the Components

1. Turn on the monitor and the component(s) you want to view.
2. Press the TV button on the remote control.
3. Press the INPUT button on the remote control to scroll through the video inputs.
 - The VCR can be viewed on the VID 1 input channel.
 - The satellite receiver can be viewed on the VID 2 input.

Direct Channel Tuning

You can set up the monitor to automatically tune to the correct input for channel. This is called auto tuning. (See "Setup" for more information.)

CONNECTIONS & SETUP

Monitor, VCR, Satellite Receiver, and a DVD Player

1. Connect the coaxial cable carrying your television signal (off air or cable) to the antenna input on the VCR.
2. Connect a coaxial cable to the VCR's antenna output and to the ANTENNA/CABLE INPUT jack on the monitor.
3. Use RCA cables to connect the VCR's audio/video output to INPUT 1 on the monitor.
4. Use RCA cables to connect the satellite receiver's audio/video output to the INPUT 2 input on the monitor. If your satellite receiver has an S-Video output, you can make the video connection by using the S-Video jacks instead.
5. Use RCA cables to connect the DVD player's audio/video output to the INPUT 3 input on the monitor. If your DVD player has an S-Video output, you can make the video connection by using the S-Video jacks instead.

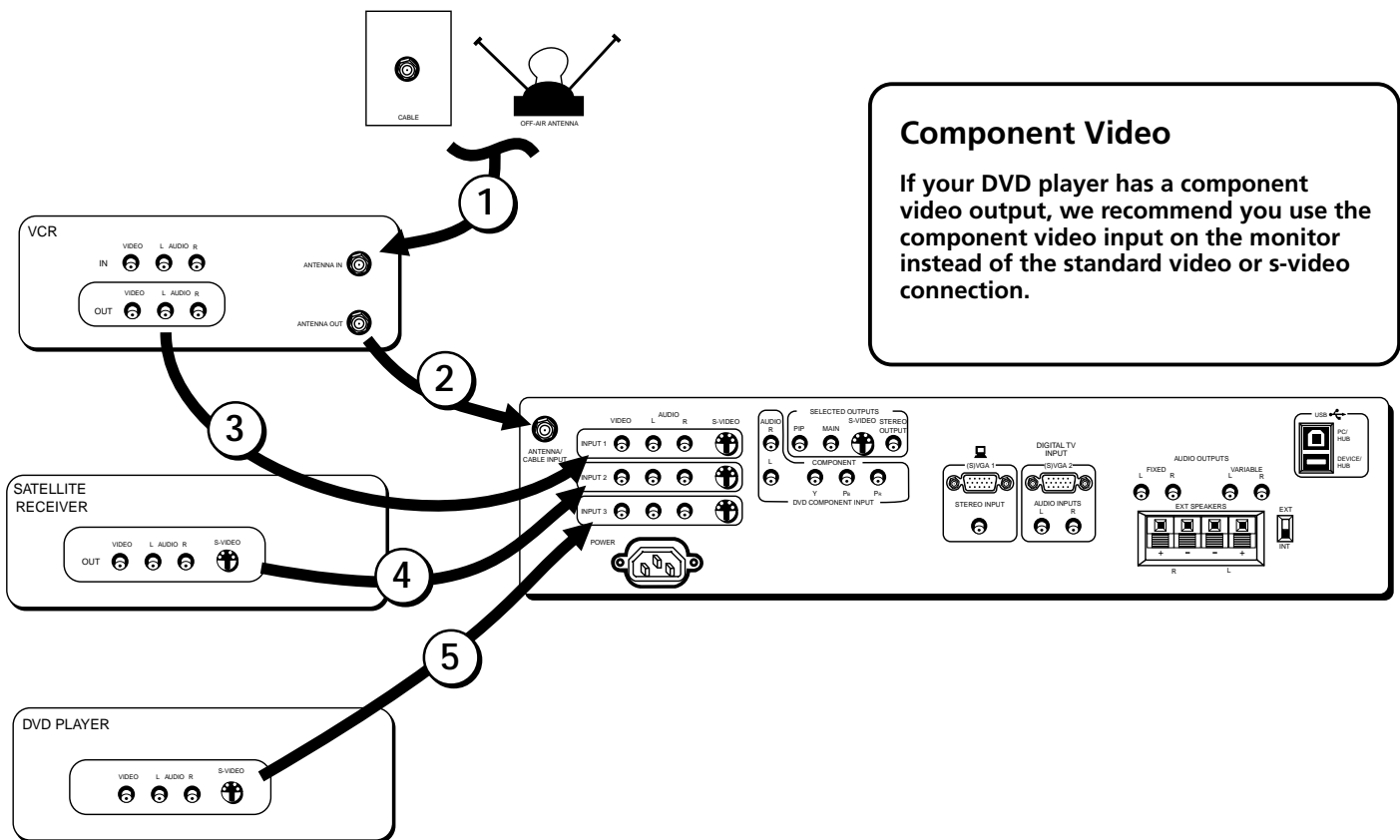

Viewing the Components

1. Turn on the monitor and the component(s) you want to view.
2. Press the TV button on the remote control.
3. Press the INPUT button on the remote control to scroll through the video inputs.
 - The VCR can be viewed on the VID 1 input channel.
 - The satellite receiver can be viewed on the VID 2 input.
 - The DVD player can be viewed on the VID 3 input.

Direct Channel Tuning

You can set up the monitor to automatically tune to the correct input for channel. This is called auto tuning. (See "Setup" for more information.)

CONNECTIONS & SETUP

A/V Receiver & Speakers

1. Use RCA cables to connect either the **FIXED** or **VARIABLE AUDIO OUTPUT** from the monitor to an **A/V receiver**.
 - **FIXED** provides fixed-level audio output from the monitor. This audio output is ideal for connecting to an A/V receiver that has its own volume control.
 - **VARIABLE** provides variable-level audio output. Volume levels are controlled by the volume controls on the monitor and monitor remote control.
2. Use speaker wire to connect the monitor to external speakers.
 - The **EXT/INT** switch beside the jacks let you turn the monitor's internal speakers on or off. **EXT** sends audio to external and internal speakers. **INT** sends audio only to the monitor's internal speakers.

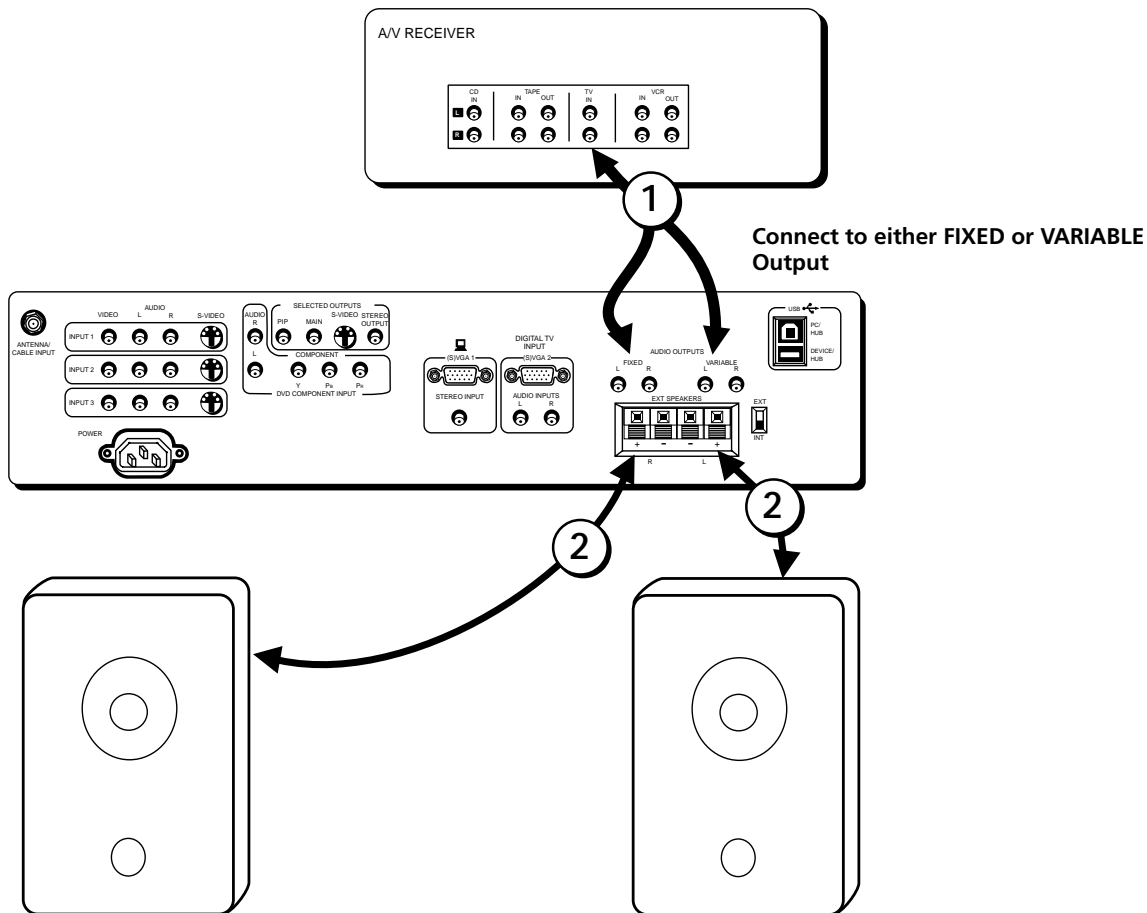

CONNECTIONS & SETUP

(S)VGA VIDEO INPUTS –(S)VGA1, (S)VGA2

The (S)VGA (Super Video Graphics Adapter) inputs let you connect your monitor to a personal computer, and internet devices. These inputs can provide up to 800 pixel x 600 pixel resolution. How images are displayed, however, depends on other factors such as the type of device connected to the monitor, the media being transmitted, graphics cards and memory allotments.

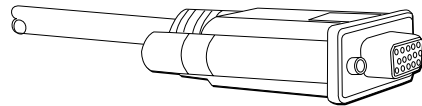
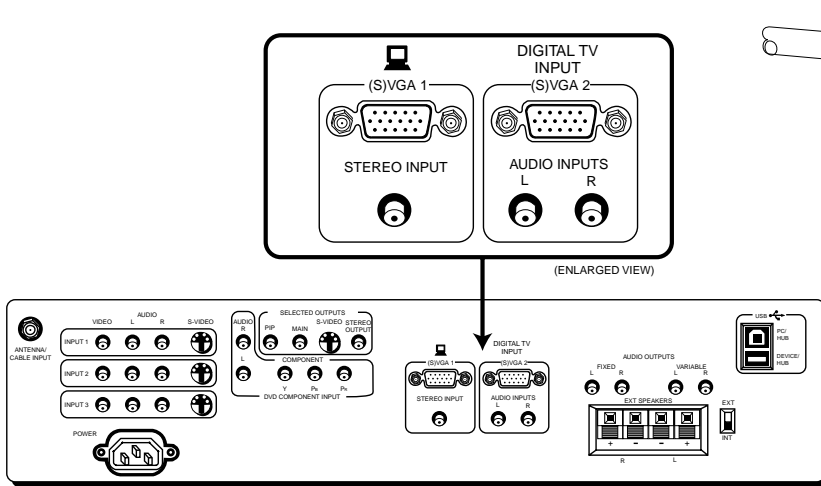

(S)VGA cable

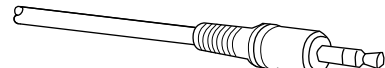

Stereo mini-jack cable

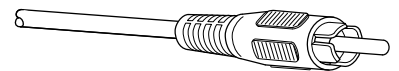

RCA cable

Scan Rates

The computer scan rates supported are:

- VGA 640x480, 60/72hz progressive
- (S)VGA 800x600, 60hz progressive

Make sure that you appropriately adjust the display properties for your computer.

You can change the picture mode settings for the (S)VGA inputs by using the *Picture Mode* menu. To access the *Picture Mode* menu, press TV and then FETCH on the remote.

Computer/Text is the default setting for the (S)VGA 1 input. This input and setting is recommended for most PC connections when viewing text and graphics. Text may not appear as crisp in Video mode.

Video is the default setting for the (S)VGA 2 input. This input and setting is recommended for high definition television (HDTV) converter connections. Also, computer games may appear better in Video mode.

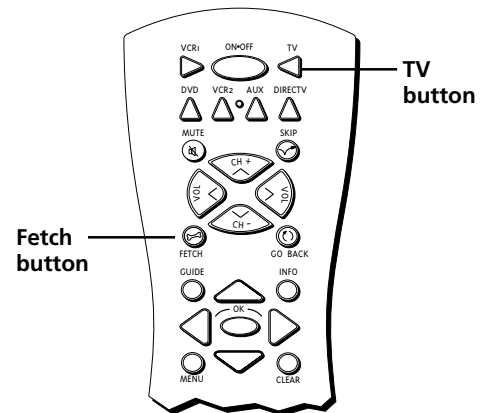

Picture Mode menu

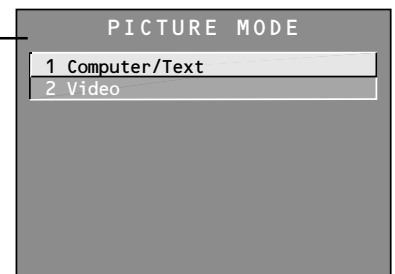

CONNECTIONS & SETUP

(S)VGA 1 Input Connection Examples

1. Connect the supplied (S)VGA cable to your computer and to the monitor.
2. Connect the audio:
 - Connect the stereo mini-jack cable to the computer and to the STEREO INPUT jack on the monitor.

OR

- Connect the RCA-type connectors of a "Y" adapter to the audio outputs on the computer, and connect the stereo mini-jack connector to the STEREO INPUT jack on the monitor.

The (S)VGA 1 input supports DDC2B and VESA DPMS when using an appropriate cable. We recommend using the VGA cable supplied with this monitor.

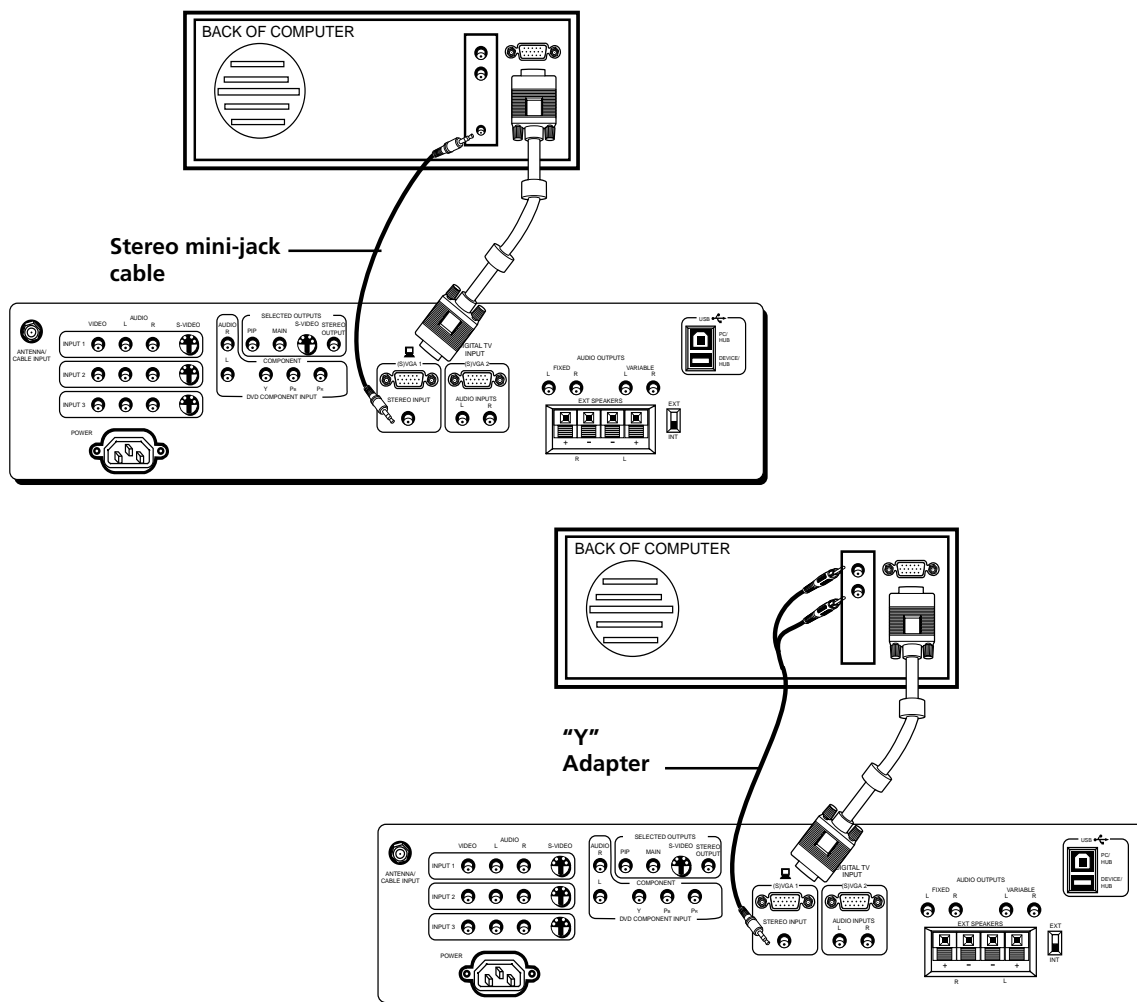

Viewing the (S)VGA 1 Input

1. Turn on the monitor and the computer.
2. Press the TV button on the remote control.
3. Press the INPUT button on the remote control to scroll through the video inputs until you get to the VGA 1 input.

(If you have difficulty getting your screen to appear on the monitor see the *Troubleshooting* section of this manual for possible solutions.)

CONNECTIONS & SETUP

(S)VGA 2 Input

The (S)VGA 2 input can be used to connect a HDTV digital receiver so that you can receive HDTV signals.

1. Connect the supplied (S)VGA cable to your HDTV digital receiver and to the monitor.
2. Connect an RCA-type cable to the left and right audio outputs on the digital set top converter and to the corresponding left and right AUDIO INPUTS associated with the (S)VGA 2 input on the monitor.
3. Connect an RCA-type cable to the video output on the HDTV digital receiver and to the video INPUT2 on the monitor.

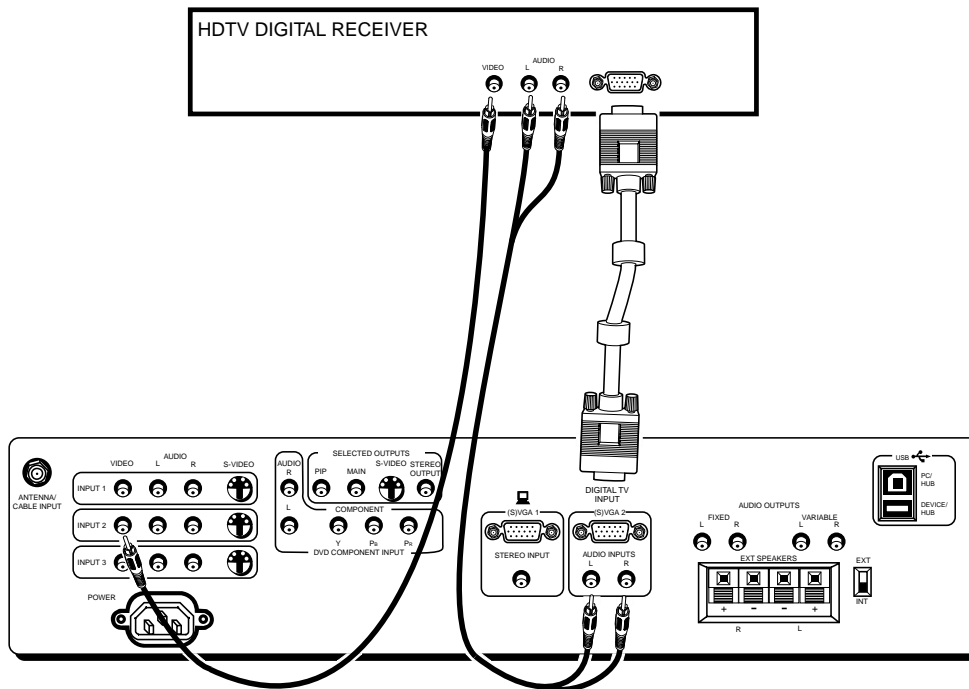

Viewing the (S)VGA 2 Input

1. Turn on the monitor and the HDTV digital receiver
2. Press the TV button on the remote control.
3. Press the INPUT button on the remote control to scroll through the video inputs until you get to the VGA 2 input.

If your RCA or PROSCAN HDTV digital receiver switches from a high definition output to a standard definition output the monitor will automatically switch from the high definition (S)VGA2 input channel to the standard definition INPUT2 (VID2) input channel in order for you to view the signal. There are two situations in which this would occur:

- When recording from the HDTV digital receiver;
- When a high definition output signal is not allowed by the program provider and/or movie studio for that particular program.

Direct Channel Tuning

You can set up the monitor to automatically tune to the (S)VGA 2 input when you press the DIRECTV button on the remote. This is called auto tuning. (See "Setup" for more information.)

CONNECTIONS & SETUP

USB INPUTS/OUTPUT

USB (universal serial bus) inputs let you connect PC-type peripheral devices to the monitor. This includes devices such as joysticks, keyboards, and pointing devices (mouse, trackball). There are three USB inputs and one USB output that connects to a PC. The monitor acts as a hub to the PC.

NOTE

The USB port will function even when the monitor is in standby mode.

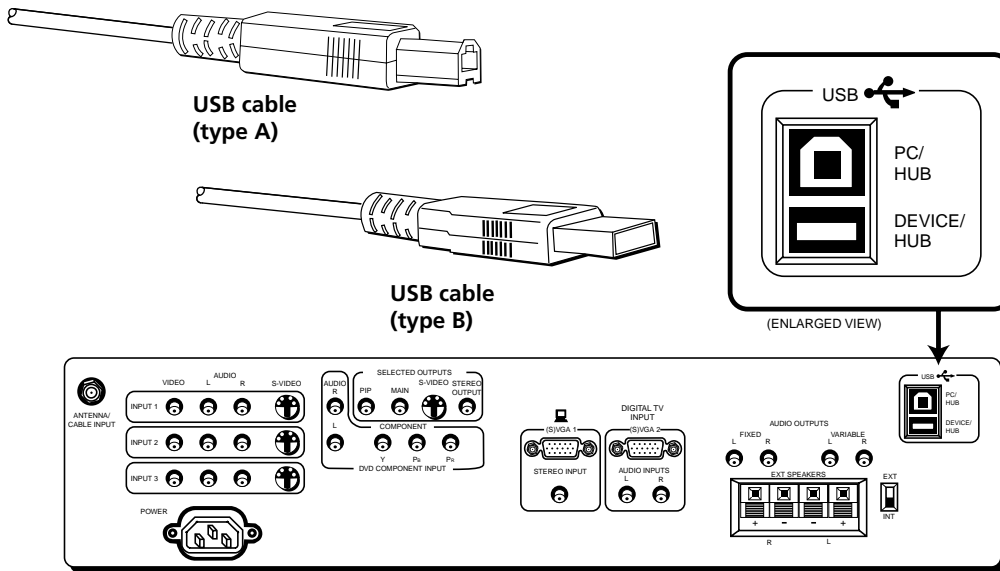

FRONT INPUTS

The monitor has front inputs for convenience; one set of audio/video inputs, a headphone jack and two client USB ports. Look for a hinged door and gently lift the cover open.

NOTE

When you plug in headphones, the monitor's speakers are turned off.

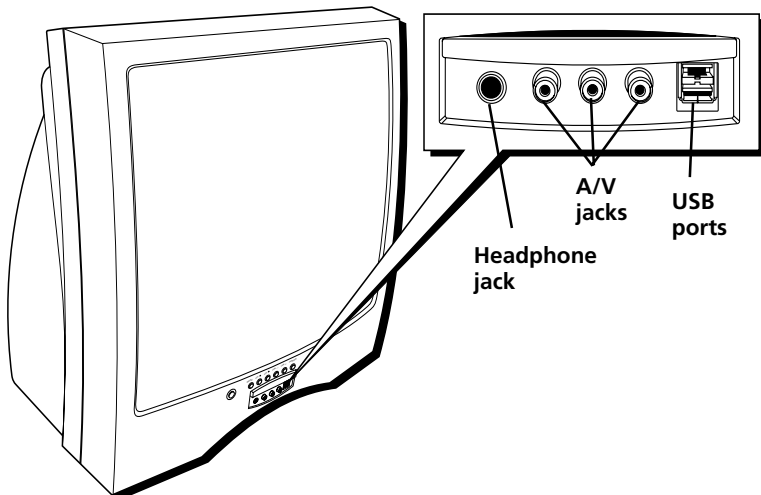

CONNECTIONS & SETUP

SETTING UP THE MONITOR

STEP 1: PLUG IN THE MONITOR

Plug the end of the power cord into an appropriate wall outlet. Be sure to insert the plug completely.

STEP 2: PLACE BATTERIES IN REMOTE

- Remove the battery compartment cover from the back of the remote.
- Insert fresh batteries. Make sure that the polarities (+ and -) are aligned correctly.
- Replace the cover.

STEP 3: TURN ON THE MONITOR

Press TV on the remote, or press POWER on the monitor's front panel.

Pressing the TV button not only turns on the monitor, but puts the remote into TV mode, so that the buttons on the remote will control monitor functions.

STEP 4: SET UP THE MONITOR

The information that follows gives you step by step instructions for the first time set up of your monitor. Take time now to read the next section, "Setting Up Your Monitor," and complete the set up routine.

FIRST TIME SET UP

The first time set up of your monitor includes: setting the time, auto channel search, setting up the auto tuning feature, and labeling the channels and inputs. Refer to this section if you ever need to reset any of these initial settings.

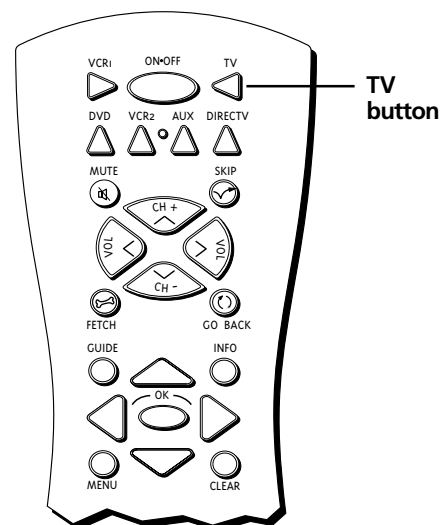

CONNECTIONS & SETUP

THE POINT AND SELECT NAVIGATION METHOD

You can “get around” in the menu system by using just a few buttons on the remote control. We call this the “Point and Select” method of navigation, and it has two steps.

1. **Point** to a menu item using the MOVE arrows on the remote.
To point up or down, press the up or down arrows. To point left or right, press the left or right arrows.
2. **Select** a menu item by pressing MENU or OK.
Selecting an item tells the monitor’s menu system to go ahead and make the change or go to a place you have indicated.

Point and Select buttons

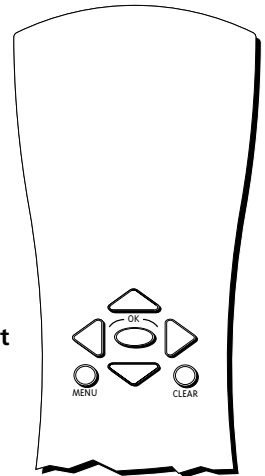

SET THE TIME

The first step in the setup is to set the time.

1. Press MENU on the remote control to bring up the Main menu.

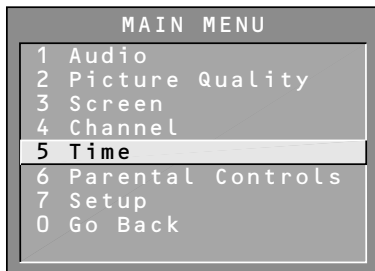

2. Point to *Time*, and press OK to select it.

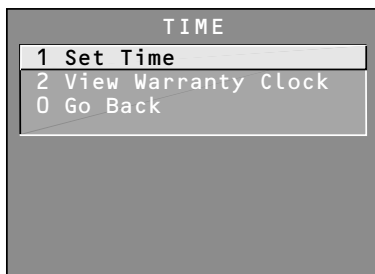

3. Point to *Set Time*, and press OK to select it.

Alternate Navigation Method

In addition to using Point & Select, you can also select a menu item by entering the item number with the number buttons on the remote.

Press CLEAR at any time to remove all displays from the screen and return to normal viewing.

Many VCR user manuals refer to a PROGRAM button. The MENU button on this remote works as a PROGRAM button in VCR mode. Other manuals may refer to a SELECT button. The OK button on this remote works as a SELECT button.

CONNECTIONS & SETUP

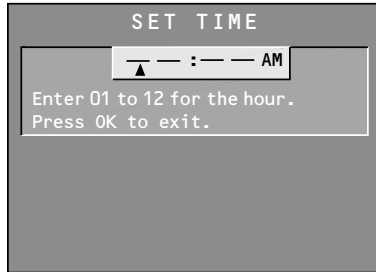

4. Use the left and right arrows to point to the hour and minutes spaces. Use the up and down arrows to scroll through the numbers and change from AM to PM. Press OK to exit.

AUTO CHANNEL SEARCH

The next step of the setup routine “autoprograms” channels into the channel list.

1. Press MENU bring up the Main menu and then select *Channel*.

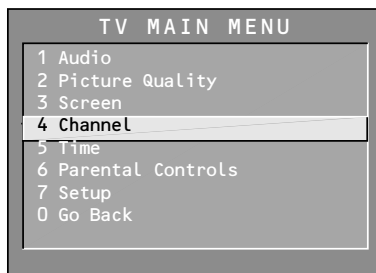

2. From the CHANNEL menu (shown below), select *Auto Channel Search*.

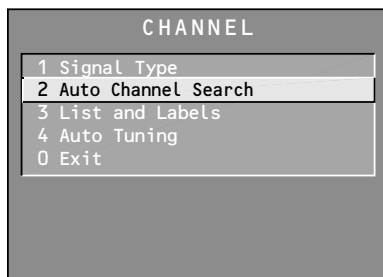

The monitor will begin searching for channels and give you a progress report. When the channel search is complete, press OK on the remote to go back to the Channel menu.

CONNECTIONS & SETUP

SET THE VCR1 CHANNEL (AUTO TUNING)

The next step lets you set the VCR1 channel. When you set the VCR1 channel, the monitor automatically tunes to the correct input channel when press the VCR1 button on the remote. This is called "Auto Tuning."

If you don't have a VCR1 component connected to the monitor, skip this step.

1. From the CHANNEL menu (shown below), select *Auto Tuning*.

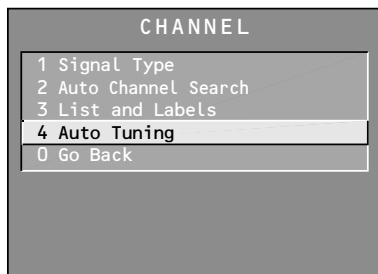

2. From the AUTO TUNING menu (shown below), select *Set VCR1 Channel*.

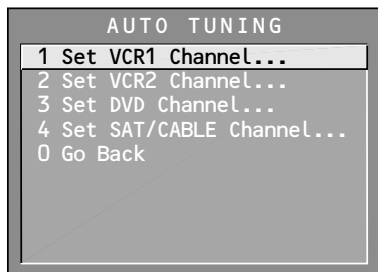

3. From the SET VCR1 CHANNEL menu (shown below), point to the choice in the that matches the way you have your VCR connected to the monitor.

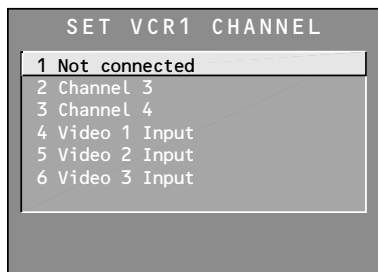

4. Press OK to select it.

CONNECTIONS & SETUP

SET THE VCR2 CHANNEL (AUTO TUNING)

You can set the VCR2 button on the remote to automatically tune to an input channel as well. If you don't have a VCR2 component connected to the monitor, skip this step.

1. From the CHANNEL menu (shown below), select *Auto Tuning*.

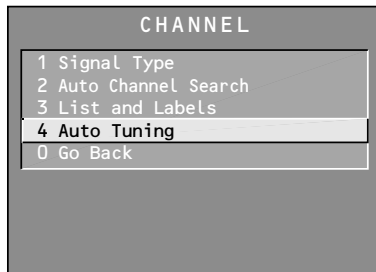

2. From the AUTO TUNING menu (shown below), select *Set VCR2 Channel*.

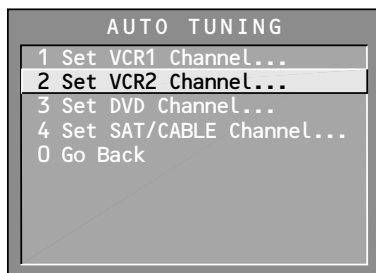

3. From the SET VCR2 CHANNEL menu (shown below), point to the choice in the that matches the way you have your VCR connected to the monitor.

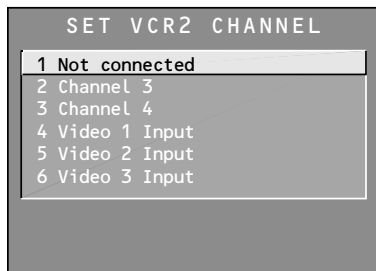

4. Press OK to select it.

CONNECTIONS & SETUP

SET THE DVD CHANNEL (AUTO TUNING)

The next step lets you set the DVD channel. When you set the DVD channel, you're telling the monitor what channel to tune to when you press the DVD button on the remote.

Indicate which input you used to connect an DVD player. If you don't have a DVD player connected to the monitor, skip this step.

1. From the CHANNEL menu (shown below), select *Auto Tuning*.

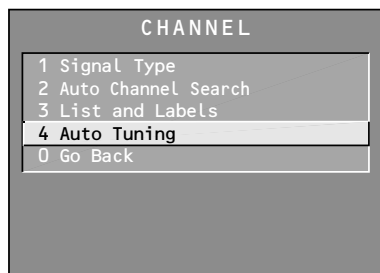

2. From the AUTO TUNING menu (shown below), select *Set DVD Channel*.

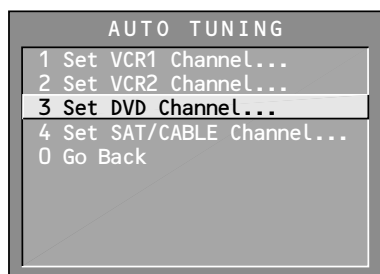

3. From the SET DVD CHANNEL menu (shown below), point to the choice in the that matches the way you have your DVD connected to the monitor.



4. Press OK to select it.

CONNECTIONS & SETUP

SET THE SAT/CABLE CHANNEL (AUTO TUNING)

The next step lets you set the SAT/CABLE channel. When you set the SAT/CABLE channel, you're telling the monitor what channel to tune to when you press the DIRECTV button on the remote.

Indicate which input you used to connect a satellite receiver, a cable box or a digital set top converter. If you don't have one of these components connected to the monitor, skip this step.

1. From the CHANNEL menu (shown below), select *Auto Tuning*.

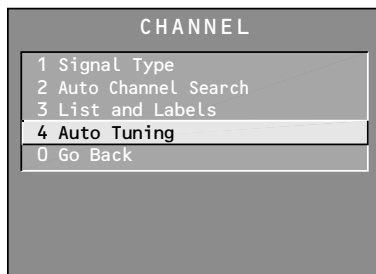

2. From the AUTO TUNING menu (shown below), select *Set SAT/CABLE Channel*.

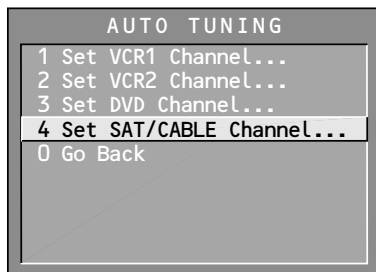

3. From the SET SAT/CABLE Channel menu (shown below), point to the choice in the that matches the way you have your satellite receiver or cable box connected to the monitor.

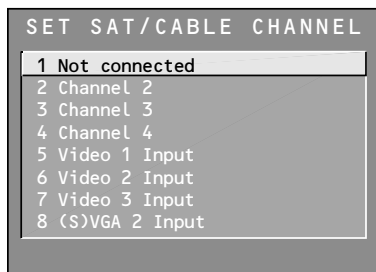

4. Press OK to select it.

CONNECTIONS & SETUP

LABEL THE CHANNELS

This last step in the setup routine lets you create your channel list and label your channels.

1. From the CHANNEL menu (shown below), select *Lists and Labels*.

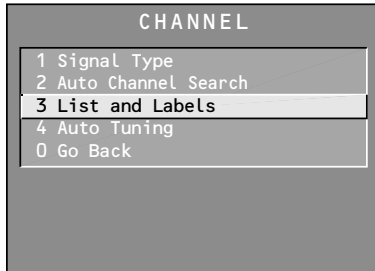

The LISTS AND LABELS menu appears (shown below).

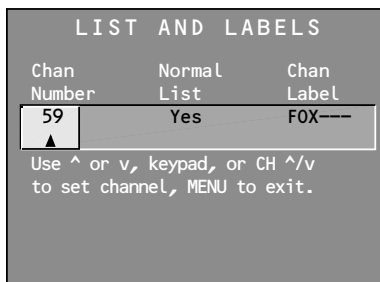

Use the CH ^ (channel up) or CH v (channel down) buttons to change channels in the Chan # field. This works even if you're not in the Chan # field. Or, enter the channel number directly using the number buttons on the universal remote. To enter a number greater than 99, press and hold "1" to enter the hundreds digit, then press the two remaining numbers.

The list and labels feature can also be accessed from the Channel menu. Because this procedure can be time consuming, feel free to skip this step and come back to it later.

2. Use the left and right arrows to point to the three different areas of the control panel (called "fields").
3. Use the up and down arrows to scroll through the numbers and letters and select *Yes* or *No* in the Normal List field. You may wish to refer to the call letters listed in your newspaper's TV section for ideas on labelling the channels.
4. Repeat this process for each of your channels. Then press MENU or OK to continue. The monitor can store in memory as many as 45 labels plus labels for each input.

WHAT NOW?

Now that you've finished the setup, you can sit back, relax, and enjoy the monitor, or you can take a few minutes to program the remote to control your VCR, DVD player, satellite receiver, or other components. To find out how to program the remote, go to the next section.

USING THE REMOTE

HOW TO USE YOUR UNIVERSAL REMOTE

This section defines the buttons of the remote and how to program it to control other components.

The universal remote can be programmed to control most brands of remote controllable VCRs, satellite receivers, and cable boxes. If you have an RCA, GE, or PROSCAN component, you probably don't need to program it at all.

1 CONNECTIONS & SETUP



2 USING THE REMOTE



3 MENUS AND FEATURES



4 REFERENCE

Modes of Operation

Because this universal remote can control several different components (DVD player, VCR, Cable Box, etc.) it uses operational modes triggered by the component buttons. For example if you want the remote to control the TV, you would press the TV button to put the remote into TV mode before you could control the TV.

USING THE REMOTE

REMOTE BUTTONS

ON•OFF When in TV mode, turns the monitor on and off. If in another device mode (VCR, DVD, Satellite(DIRECTV), etc.) and programmed, will turn the device on and off. Press twice within two seconds to turn off most PROSCAN, RCA and GE products at once.

VCR1 Puts the remote in VCR mode and if auto tuning is enabled, it will turn on the monitor and tune to the correct channel.

TV Turns on the monitor and puts the remote in TV mode. Also displays channel information.

DVD Puts the remote in DVD mode and if auto tuning is enabled, it will turn on the monitor and tune to the correct channel.

VCR2 Puts the remote in VCR2 mode and if auto tuning is enabled, it will turn on the monitor and tune to the correct channel.

LED The LED light indicates programming mode when programming the remote to control components.

AUX Puts the remote in AUX mode. Also, turns on the monitor.

DIRECTV Puts the remote in satellite mode and if auto tuning is enabled, it will turn on the monitor and tune to the correct channel.

MUTE Reduces the monitor's volume to its minimum level. Press again to restore the volume.

SKIP Press once before changing channels and the monitor will wait 30 seconds before returning you to the original channel. Press repeatedly to add more time.

CH ^ or CH v Scans up or down through the current channel list. Press once to change the channel up or down; press and hold to continue changing channels.

VOL - or VOL + Decreases or increases the monitor's volume.

FETCH Brings up Picture Mode choice list (*Computer/text or Video*) when tuned to VGA1 or VGA2. Some ProScan, RCA and GE devices use FETCH as a shortcut to menu items.

GO BACK Returns you to the previous channel or previous screen in the menu system.

GUIDE In satellite (DIRECTV) mode brings up available on-screen guides.

INFO Brings up channel information; press again to clear the screen.

MOVE (Arrows) Used to point to different items in the menu system and adjust the menu controls. Also moves the PIP window when no menus are on the screen.

OK When in the menu system, selects highlighted items or returns you to the previous menu.

MENU Brings up the Main menu and selects highlighted items. When in VCR mode, it functions as a PROGRAM button.

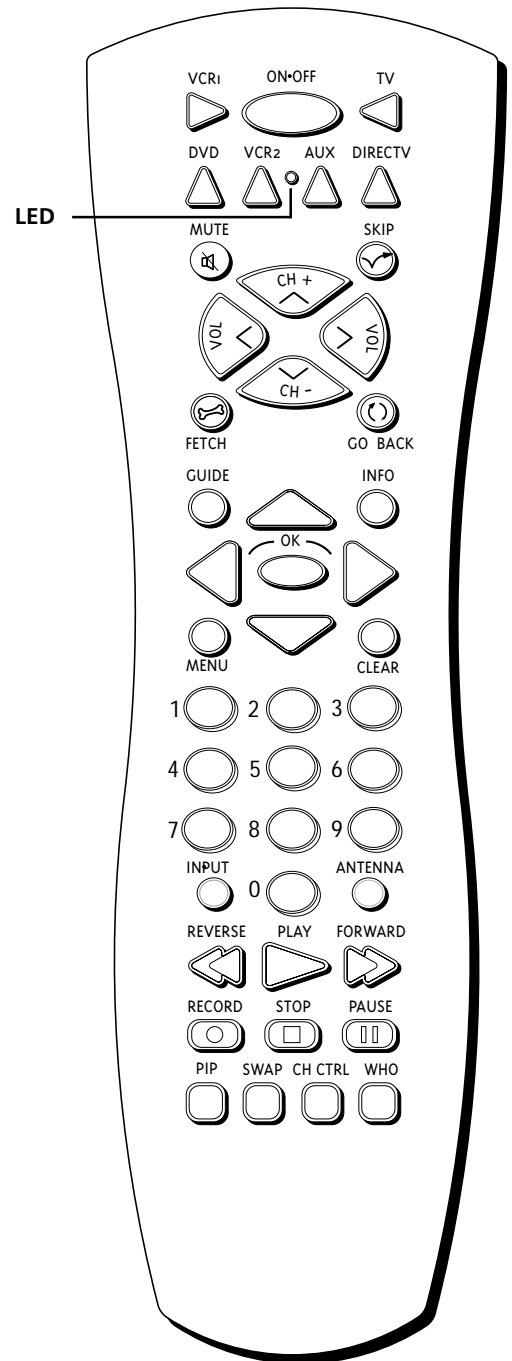

NOTE

The VCR1, DVD, VCR2, and DIRECTV buttons also turn on most RCA, GE and ProScan products.

USING THE REMOTE

CLEAR Removes any menu or display from the screen and returns you to normal viewing.

(0-9) Number Buttons Enters channel numbers and time settings directly through the remote control. To enter a two-digit channel, press the two digits. To enter a three-digit channel, press and hold the first digit until the number and two dashes “--” appear, then add the second two. Example: to tune to channel 123, press and hold 1 until “1--” appears, release the 1 button and then press 2, and 3.

INPUT In TV mode, press to toggle through the available input sources (VID1, VID2, VID3, last channel, VGA1, VGA2, component input).

ANTENNA Functions as TV/VCR button in VCR mode and TV/receiver button in satellite (DIRECTV) mode.

REVERSE, PLAY, FORWARD, RECORD, STOP, PAUSE If programmed, provides transport control for some remote-controllable VCRs, DVD players, laserdisc players, tape decks, and CD players.

PIP Brings up the small picture-in-picture window. Press again to remove the PIP window. (See “PIP Feature” later in this manual for more information about using PIP.)

SWAP Swaps the main picture with the PIP window.

CH CTRL Selects the picture window, (that is, the main or PIP window) to be changed by the CH ^ (channel up) or CH v (channel down) buttons.

WHO Some RCA, ProScan and GE components use the WHO button to toggle through available channel lists and user profiles.

USING THE INPUT BUTTON

Use the INPUT button to scroll through the available input channels and view components you have connected to the monitor.

1. Press TV to place the remote in TV mode. Make sure that the component you want to view is turned ON.
2. Press INPUT to tune to an available input channel.
3. Continue to press the INPUT button to scroll through the channels.

PROGRAMMING THE REMOTE

The universal remote can be programmed to control most brands of remote controllable VCRs, satellite receivers and cable boxes. The remote is already programmed to control most PROSCAN, RCA and GE TVs, VCRs, DVD players, laserdisc players and satellite receivers.

TESTING THE REMOTE

To determine whether the universal remote needs to be programmed, turn a device ON, such as a VCR, point the remote at the VCR, and press the VCR1 button. Then press POWER or CH ^ (channel up) or CH v (channel down) to see if the VCR responds to the remote commands. If not, the remote needs to be programmed.

Modes of Operation

Because this universal remote can control several different components (DVD player, VCR, Cable Box, etc.) it uses operational modes triggered by the component buttons. For example if you want the remote to control the TV, you would press the TV button to put the remote into TV mode before you could control the TV.

USING THE REMOTE

PROGRAMMING THE REMOTE

Using Automatic Code Search

The following instructions can be used to program the remote to control each of the devices connected to your monitor. If you want to exit the automatic code search without programming any of your devices, press and hold CLEAR until the LED turns off.

1. Turn on the device you want to control (VCR, digital satellite receiver, etc.).
2. Press and hold the button you want to program (VCR1, DIRECTV, etc.). While holding the device button, press and hold ON•OFF until the red light on the remote turns on, then release both buttons.
3. Point the remote at the device, press and release PLAY, then wait 5 seconds or until the LED stops flashing.

At this point the remote is searching for the correct code to program. If, after 5 seconds or until the LED stops flashing, the device you want to control does not turn off, press PLAY again to tell the remote to search the next set of codes.

Continue pressing PLAY until the device turns off or you have searched through all of the codes. There are 20 total sets of codes. If the device does not turn off after pressing PLAY 20 times, then the remote cannot control that particular device.

If the device you want to control *does* turn off:

1. Press and release REVERSE, then wait 2 seconds. Repeat this step until the device turns back ON.
2. To finish, press and hold STOP until the red light on the remote turns off.

Using Direct Entry

1. Turn on the component to be programmed.
2. Look up the brand and code number(s) for the component on the code list on the last page of this section.
3. Press and hold the button on the remote you want to program.
4. Enter the code from the code list.
5. Release button, and then press ON•OFF to see if the component responds to the remote commands. If it doesn't, try pressing the component button and then ON•OFF again.
6. If you get no response, repeat these steps using the next code listed for your brand, until the component responds to the remote commands.

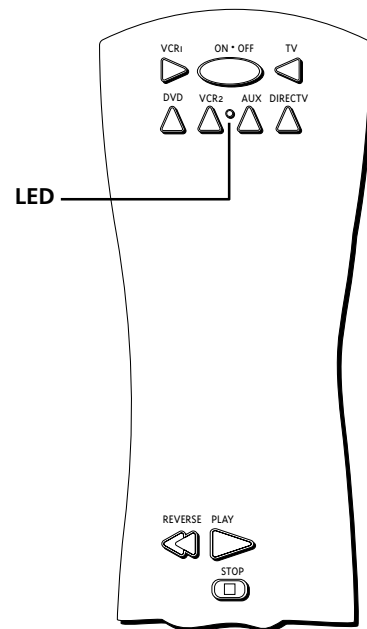

You'll use these buttons when you program the remote.

The remote may not operate all models of all brands.

USING THE REMOTE

USING THE REMOTE TO CONTROL A DEVICE

Once the remote has been programmed successfully, you are ready to use it to control your devices.

To operate the device:

1. Press the device button (TV, VCR1, VCR2, DVD, AUX, or DIRECTV) to set the remote to control the device.
2. Press ON•OFF to turn the device ON or OFF.
3. Use the remote buttons that apply to that device.

MODES OF OPERATION

Because this universal remote can control several different components (DVD player, VCR, Cable Box, etc.) it uses operational modes triggered by the component buttons. For example if you want the remote to control the monitor, you would press the TV button to put the remote into TV mode before you could control the monitor.

FRONT PANEL

If you cannot locate your remote you can use the front panel of your monitor to operate many of the monitor's features.

MENU/OK Brings up the Main menu. When in the menu system, it selects highlighted items. Also returns you to the previous menu.

CH v Scans down through the current channel list. In the menu system, it points down to items and adjusts menu controls.

CH ^ Scans up through the channel list. In the menu system, it points up to items and adjusts menu controls.

VOL < Decreases the volume. When in the menu system, VOL < is used to point left to items and adjust menu controls.

VOL > Increases the volume. When in the menu system, VOL > is used to point right to items and adjust menu controls.

POWER Turns the monitor on and off.

The front panel below shows a typical button layout. The exact look of the buttons may be different from those on the front of your monitor.

If you use the Channel Block feature, the front panel no longer provides access to the menus. The Front Panel Lockout feature disables all front panel buttons. For more information, see Parental Control, in the *Features and Menus* section.

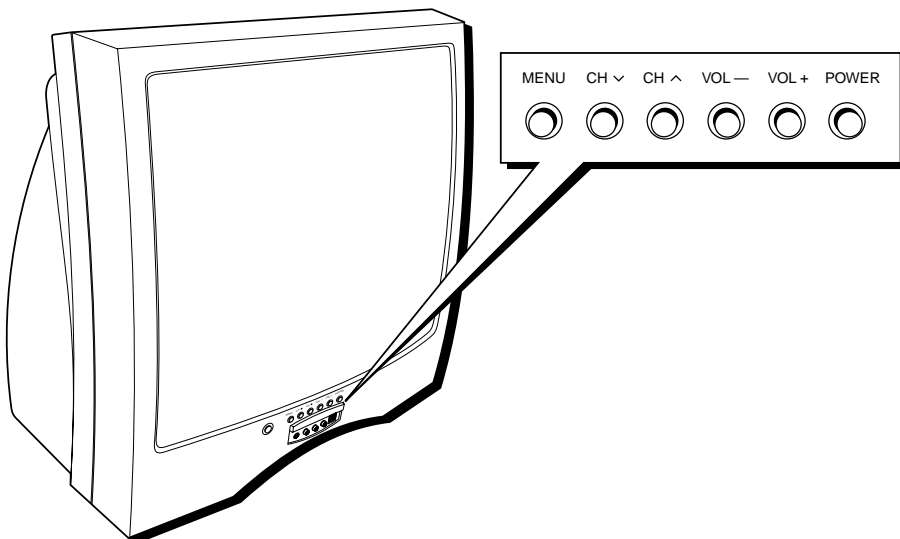

USING THE REMOTE

VCR

Admiral	2131
Adventura	2026
Aiko	2027
Aiwa	2002, 2026
Akai	2003, 2004, 2005, 2007, 2008, 2111, 2112, 2113
American High	2021
Asha	2013
Audio Dynamics	2009, 2010
Audiovox	2014
Bell & Howell	2011
Beaumarck	2013
Broksonic	2012, 2025
Calix	2014
Candle	2013, 2014, 2015, 2016, 2017, 2018, 2019
Canon	2021, 2022, 2114
Capehart	2020, 2110
Carver	2062
CCE	2027, 2061
Citizen	2013, 2014, 2015, 2016, 2017, 2018, 2019, 2027
Colortyme	2009
Colt	2061
Craig	2013, 2014, 2023, 2061
Curtis-Mathes	2000, 2002, 2009, 2013, 2016, 2018, 2021, 2022, 2024, 2115
Cybernex	2013
Daewoo	2015, 2017, 2019, 2025, 2026, 2027, 2028, 2110
Daytron	2110
Dbx	2009, 2010
Dimensia	2000
Dynatech	2002, 2026
Electrohome	2014, 2029
Electroponic	2014
Emerson	2002, 2012, 2014, 2015, 2021, 2024, 2025, 2026, 2029, 2030, 2032, 2033, 2034, 2035, 2036, 2037, 2038, 2039, 2040, 2041, 2042, 2044, 2045, 2047, 2065, 2105, 2113, 2116, 2117, 2130
Fisher	2011, 2023, 2048, 2049, 2050, 2051, 2052, 2118
Fuji	2021, 2119
Funai	2002, 2026
Garrard	2026
GE	2000, 2001, 2013, 2021, 2022, 2053, 2115, 2120
Goldstar	2009, 2014, 2018, 2054, 2121
Gradiente	2026
Harley Davidson	2026
Harman Kardon	2009
Harwood	2061
Headquarter	2011
Hitachi	2002, 2055, 2056, 2057, 2107, 2111, 2120, 2122
Hi-Q	2023
Instant Replay	2021
JCL	2021
JC Penney	2009, 2010, 2011, 2013, 2014, 2021, 2022, 2055, 2056, 2058, 2059, 2060, 2107, 2118
Jensen	2055, 2056, 2111
JVC	2009, 2010, 2011, 2018, 2058, 2111, 2123
Kenwood	2009, 2010, 2011, 2016, 2018, 2058, 2111, 2123
KLH	2061
Kodak	2014, 2021
Lloyd	2002, 2026
Logik	2061
LXI	2014
Magnavox	2021, 2022, 2062, 2063, 2104, 2108, 2124
Magnin	2013
Marantz	2009, 2010, 2011, 2016, 2018, 2021, 2058, 2062, 2064
Marta	2014
Masushita	2021
MEI	2021
Memorex	2002, 2011, 2013, 2014, 2021, 2023, 2026, 2104, 2131
MGA	2029, 2065, 2113
MGN Technology	2013
Midland	2053
Minolta	2055, 2056, 2107
Mitsubishi	2029, 2055, 2056, 2065, 2066, 2067, 2069, 2070, 2071, 2072, 2073, 2074, 2106, 2113, 2123

Montgomery Ward	2075, 2131
Motorola	2021, 2131
MTC	2002, 2013, 2026
Multitech	2002, 2013, 2016, 2026, 2053, 2061
NEC	2009, 2010, 2011, 2016, 2018, 2058, 2064, 2076, 2078, 2079, 2111, 2123
Nikko	2014
Noblex	2013
Olympus	2021
Optimus	2014, 2131
Optonica	2096
Orion	2035
Panasonic	2021, 2022, 2109, 2125, 2126, 2127
Pentax	2016, 2055, 2056, 2107, 2120
Pentex Research	2018
Philco	2021, 2022, 2062, 2063
Philips	2021, 2062, 2096, 2124
Pilot	2014
Pioneer	2010, 2055, 2080, 2081, 2123
Portland	2016, 2017, 2019, 2110
Proscan	2000, 2001
Protec	2061
Pulsar	2104
Quarter	2011
Quartz	2011
Quasar	2021, 2022, 2125
RCA	2000, 2001, 2003, 2013, 2021, 2055, 2056, 2082, 2083, 2084, 2085, 2086, 2087, 2088, 2089, 2090, 2091, 2107, 2115, 2120, 2125
Radioshack/Realistic	2002, 2011, 2013, 2014, 2021, 2022, 2023, 2026, 2029, 2049, 2050, 2096, 2131
Radix	2014
Randex	2014
Ricoh	2128
Runco	2104
Samsung	2005, 2013, 2015, 2033, 2053, 2112
Sanky	2132, 2104
Sansui	2010, 2092, 2111, 2123
Sanyo	2011, 2013, 2023
Scott	2012, 2015, 2025, 2032, 2035, 2038, 2065, 2093, 2116
Sears	2011, 2014, 2021, 2023, 2048, 2049, 2050, 2051, 2055, 2056, 2107, 2118
Sharp	2002, 2017, 2029, 2094, 2095, 2096, 2131
Shintom	2004, 2056, 2061, 2098
Shogun	2013
Signature	2002, 2131
Singer	2021, 2061, 2128
Sony	2002, 2004, 2098, 2099, 2119, 2128
STS	2021, 2107
Sylvania	2002, 2021, 2022, 2026, 2062, 2063, 2065, 2124
Symphonic	2002, 2026
Tandy	2002, 2011
Tashiko	2014
Tatung	2058, 2111
TEAC	2002, 2026, 2058, 2085, 2111
Technics	2021, 2109
Teknika	2002, 2014, 2021, 2026, 2100, 2129
Tmk	2013, 2024, 2047
Toshiba	2015, 2049, 2051, 2055, 2065, 2093, 2116
ToteVision	2013, 2014
Unitech	2013
Vector Research	2009, 2010, 2015, 2016
Victor	2010
Video Concepts	2009, 2010, 2015, 2016, 2113
Videosonic	2013
Wards	2002, 2013, 2014, 2015, 2021, 2023, 2026, 2029, 2055, 2056, 2061, 2096, 2101, 2102, 2103, 2107, 2116, 2131
XR-1000	2021, 2026, 2061
Yamaha	2009, 2010, 2011, 2018, 2058, 2111
Zenith	2004, 2098, 2104, 2119, 2128

Audio

(For RCA and Dimensia brands only)

AM/FM	4003
Aux	4004
Phono	4005
CD	4007
Tape	4006

Cable Boxes

ABC	5002, 5003, 5004, 5005, 5006, 5007, 5053
Antronix	5008, 5009
Archer	5008, 5009, 5010, 5011
Cabletenna	5008
Cableview	5008
Century	5011
Citizen	5011
Colour Voice	5012, 5013
Comtronics	5014, 5015
Contec	5016
Eastern	5017
Garrard	5011
GC Electronics	5009
Gemini	5018, 5019, 5049
General Instrument	5003
Hamlin	5020, 5021, 5022, 5035, 5045
Hitachi	5003
Hytex	5002
Jasco	5011
Jerrold	5003, 5005, 5007, 5018, 5023, 5024, 5046, 5053
Magnavox	5025
Memorex	5026
Movie Time	5002, 5027, 5028
NSC	5002, 5027, 5028
Oak	5002, 5016, 5029
Panasonic	5048, 5052
Paragon	5026
Philips	5011, 5012, 5013, 5019, 5025, 5030, 5031, 5032
Pioneer	5033, 5034
Pulsar	5026
RCA	5047, 5049, 5052
Realistic	5009, 5049
Regal	5022, 5035
Regency	5017
Rembrandt	5003
Runco	5026
Samsung	5014, 5034
Scientific Atlanta	5006, 5036, 5037, 5038
Signal	5014, 5018
Signature	5003
SL Marx	5014
Sprucer	5052
Starcom	5007, 5018, 5053
Stargate	5014, 5018
Starquest	5018
Tandy	5040
Teleview	5014
Tocom	5004, 5023, 5041
Toshiba	5026
Tusa	5018
TV86	5027
Unika	5008, 5009, 5011
United Artists	5002
United Cable	5053
Universal	5008, 5009, 5010, 5011
Videoway	5044
Viewstar	5015, 5025, 5027, 5040
Zenith	5026, 5050, 5051

Satellite Receivers

Chapparral	5056, 5057
Drake	5058, 5059
GE	5000, 5001
General Instruments	5060, 5061, 5062
Panasonic	5075
Primestar	5076
Proscan	5000, 5001
RCA	5000, 5001
Realistic	5063
Sony	5072
STS1	5064
STS2	5065
STS3	5066
STS4	5067
Toshiba	5068, 5073
Uniden	5069

MENUS AND FEATURES

USING THE MONITOR

This section explores the features and menus of your monitor beginning with some information on using menus and control panels.

Each menu is then outlined and special features are detailed in order to help you get the most from your monitor.

1 CONNECTIONS & SETUP



2 USING THE REMOTE



3 MENUS AND FEATURES



4 REFERENCE

MENUS AND FEATURES

MENUS AND CONTROL PANELS

Using the buttons on both the remote and front panel enable you to access and make changes to the Menus and Control Panels.

Menus use the point and select rule to navigate, but control panels use a variety of methods to adjust features on your monitor. The following pages detail how to use these controls in order to customize the functions of your monitor.

MENUS

The first menu is called the Main menu. Press MENU on the remote or on the front panel to bring up the Main menu:

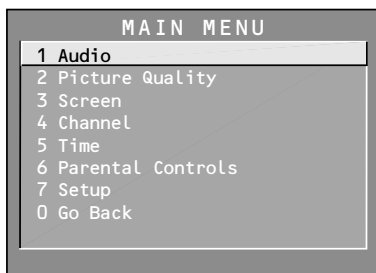

Menus take you to another menu or a control panel. There are two ways to select a choice in a menu:

- Point with the MOVE arrows and then select with MENU or OK.
- Press a number button on the remote. For example, in the Main menu press 3 to go straight to the Screen menu.

Exiting a menu

There are three ways to exit a menu:

- Point to *Go Back* and press MENU or OK.
- Press 0 on the remote.
- Press CLEAR. The on-screen displays are cleared from the screen and you are returned to normal viewing.

Feel free to explore the menu system. If you're ever unsure where you are in the menu system, or you're just plain tired of exploring, press CLEAR to remove the menus from the screen and start over again.

MENUS AND FEATURES

CONTROL PANELS

Control Panels allow you to adjust the default settings on many features of your monitor. You can choose a setting, enter a number, or adjust a level such as tint or brightness. There are three types of control panels: sliders, choice lists, and numeric entry.

Sliders

Sliders are used to make adjustments to a particular control.

To use a Slider in a menu:

1. Press the up or down arrow to select the slider control for the feature you want to adjust.
2. Press the right or left arrow to adjust the indicator line on the slider.

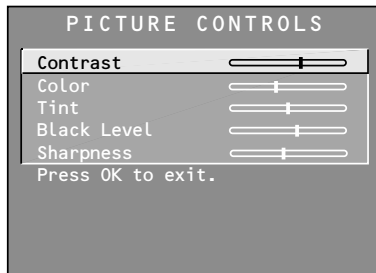

Numeric Entry

A numeric entry control panel is used to enter numbers or letters.

A pointer appears underneath the column you are changing.

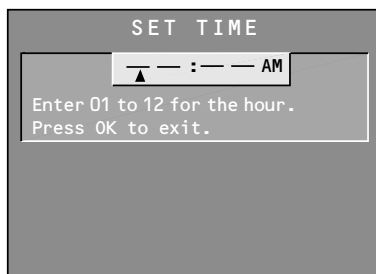

1. Press the up arrow to enter a number in the column above the pointer.
2. Press the right arrow to move to the next column, then press the up or down arrow to enter a number.
3. When you have finished entering information, press MENU or OK.

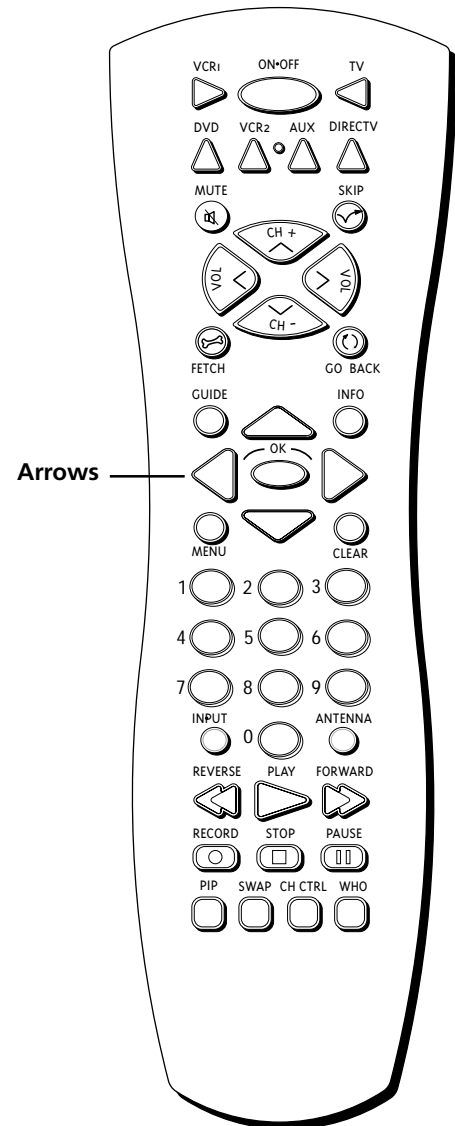

If the control panel is not set at the current time, use the left arrow to go back over the columns and the up arrow to make changes.

You can also enter numbers directly by using the number buttons.

MENUS AND FEATURES

CHOICE LISTS

Choice lists are used to choose a particular setting from a list of settings.

1. Point to a choice from the list and press MENU or OK to select that choice.

Now that you know how to access the menus and adjust the control panels the following pages provide a brief explanation of all the menu features. The features are organized in order of their location on the Main Menu.

AUDIO MENU

Mute Press OK to reduce the monitor's volume to its minimum level. Press OK again to restore the volume.

Tone Controls Displays the slider controls for adjusting the monitor's treble, bass and balance.

Audio Processor Displays a choice list of available audio modes, which control the way the sound comes through your speakers.

Mono Plays the sound in mono only. Use this setting when receiving broadcasts with weak stereo signals.

Stereo Splits the incoming stereo audio signal into left and right channels. Most TV programs and recorded materials have stereo audio. The monitor displays the word STEREO when you tune to a program that is broadcast in stereo.

SRS Stereo (•) SRS* is an audio processing technology that adds greater depth and stereo separation to stereo audio signals.

Enhanced SRS Stereo Enhances the SRS signal to give the impression of even greater depth and stereo separation.

Second Audio Program (SAP) Plays the program's audio in a second language, if one is available. The monitor displays the word SAP when you tune to a program that is broadcast with SAP information. SAP audio is broadcast in mono. SAP is also used to broadcast a program's audio with descriptions of the video for the visually impaired.

Speakers Displays a choice list that lets you turn the monitor's internal speakers on or off.

Sound Logic Sound Logic monitors a program's audio track and limits the volume to a maximum volume range. Whenever you adjust the volume on the monitor, the maximum volume range adjusts, too.

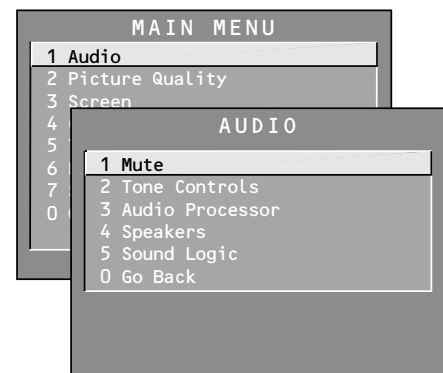
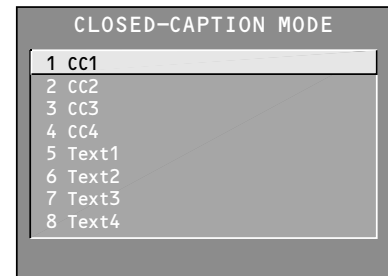

* SRS, Sound Retrieval System and the SRS logo are registered trademarks of SRS Labs, Inc.

MENUS AND FEATURES

PICTURE QUALITY MENU

Basic Picture Controls Displays the five slider controls for adjusting the way the picture looks. You can adjust and save different settings for each input.

Contrast Adjusts the difference between the light and dark areas of the picture.

Color Adjusts the richness of the color.

Tint Adjusts the balance between the red and green levels.

Black Level Adjusts the brightness of the picture.

Sharpness Adjusts the crispness of edges in the picture.

When exiting this menu the *Save Personal Picture Preset Choice List* will appear. You can choose either *Yes* or *No*.

When tuned to a VGA input, *Color*, *Tint*, *Black Level*, and *Sharpness* do not appear in the list and are not available in Text mode.

Picture Presets Displays a choice list that lets you select one of three preset picture settings: *Bright Lighting*, *Normal Lighting*, *Soft Lighting* or *Personal Picture Presets*. Choose the setting that is best for your viewing environment and edit your Personal Picture Preset.

Auto Color Displays a choice list that lets you turn on the feature that automatically corrects the color of the picture. (This is especially useful for tracking realistic flesh tone colors as you switch from channel to channel.) Choose *On* or *Off*, depending on your preference. Auto Color is not available for VGA or component video.

Color Warmth Displays a choice list that lets you set one of three automatic color adjustments: *Cool* for a more blue palette of picture colors; *Normal*; and *Warm* for a more red palette of picture colors. The warm setting corresponds to the NTSC standard of 6500°K.

Video Noise Reduction Displays a choice list that lets you turn on the feature that automatically reduces noise from the picture. Video Noise Reduction is not available in Text mode.

Picture Mode The picture mode control panel appears when the monitor is tuned to a VGA input.

Computer/Text is the default setting for the (S)VGA 1 input. This input and setting is recommended for most PC connections when viewing text and graphics. Text will not appear as crisp in Video mode.

Video is the default setting for the VGA2 input. This input and setting is recommended in such instances as HDTV digital receiver connections.

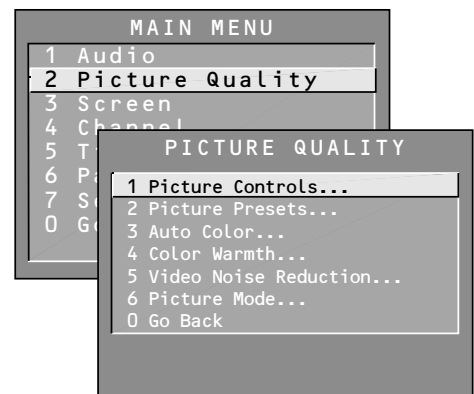

MENUS AND FEATURES

SCREEN MENU

Closed-Caption Display Displays a choice list that lets you choose the way closed captioning information is shown on the screen. Closed-captioning is not available with the VGA inputs.

Off No captioning information displayed.

On Captioning information shown always, when available.

On When Sound is Muted Displays captioning information, when available, whenever the monitor's sound is muted by pressing the MUTE button. The captioning information is not displayed when the sound is not muted.

Many programs are encoded with closed captioning information, which lets you display the audio portion of a program as text on the monitor screen. Closed captioning is not available on all channels at all times. Only specific programs encoded with closed captioning information are applicable. When a program is closed captioned, the letters CC are displayed in the channel marker.

Closed-Caption Mode Displays a choice list that lets you choose which captioning mode is used for displaying captioning information. If you are unsure of the differences among the modes, you may prefer to leave the closed captioned mode set to CC1, which displays complete text of the program in the primary language in your area.

Picture Tilt Your monitor has an extra-large picture tube which makes it vulnerable to the effects of the Earth's magnetic field. You may need to adjust the picture tilt. Use the left and right arrow buttons to adjust the picture tilt.

***Picture Position** This menu item appears when the monitor is tuned to a VGA input. This control adjusts the horizontal and vertical position of the main picture window. Use the arrows on the remote control to move the window. Press OK to set the positioning.

***Picture Size** This menu item appears when the monitor is tuned to a VGA input. This control adjusts the horizontal and vertical size of the main picture window. Use the arrows on the remote control to adjust the size, then press OK to set the size.

Background Color This menu item lets you choose between blue and transparent backgrounds.

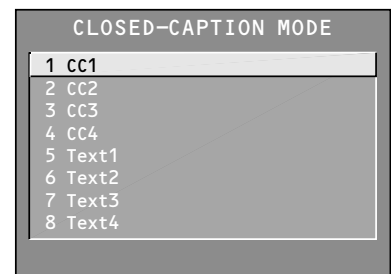
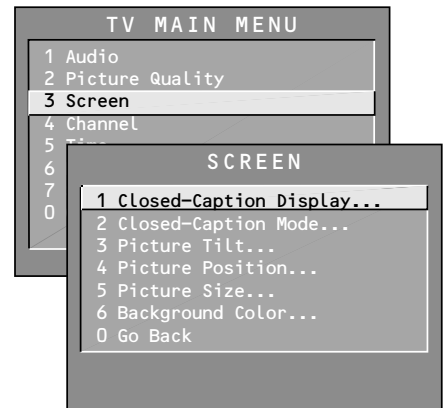

*These options are not available when an HDTV digital receiver or computer of similar frequency is connected to one of the (S)VGA inputs.

MENUS AND FEATURES

CHANNEL MENU

Signal Type Displays a choice list that lets you select the current antenna type.

UHF/VHF Antenna Choose this if you are currently using an off-air antenna for TV signals.

Cable TV Choose this if you are currently using cable or a cable box for TV signals.

Auto Channel Search Tells the monitor to search automatically for all the channels available through the antenna input. When the monitor finds an active channel, it places it in the channel list; inactive channels (weak stations or channels with no signal at all) will be removed from the channel list. Video Input channels can also be added later in the Lists and Labels control panel.

List and Labels Displays a control panel that lets you custom-build your channel list and choose a six-character label for up to 45 channels. Follow the on-screen directions to enter your channels and other information.

Channel Number Use the up and down arrows to scroll up and down through the channel scan list. You can enter the channel number directly using the number buttons.

Channel List Only the channels included in the Normal list are available when you scan up and down using the CH buttons. Use the up and down arrows to indicate whether the channel number indicated is included (*Yes*) or is not included (*No*) in the Normal channel list.

Channel Labels Use the up and down arrows to enter a six-character label for up to 45 channels. Hold the button down to scroll quickly through the characters.

Auto Tuning Displays a choice list that lets you set up the monitor to automatically tune to the correct input channel when you press a component button (VCR1, VCR2, DVD, or DIRECTV) on the remote.

Set VCR1 Channel Displays a choice list that lets you select the channel that the monitor tunes to when you press the VCR1 button.

Set VCR2 Channel Displays a choice list that lets you select the channel that the monitor tunes to when you press the VCR2 button.

Set DVD Channel Displays a choice list that lets you select the channel that the monitor tunes to when you press the DVD button.

Set SAT Channel Displays a choice list that lets you select the channel that the monitor tunes to when you press the DIRECTV button.

After you have selected the device button you want to auto tune, you need to select the input you want the monitor to tune to when you press that button. The available options include:

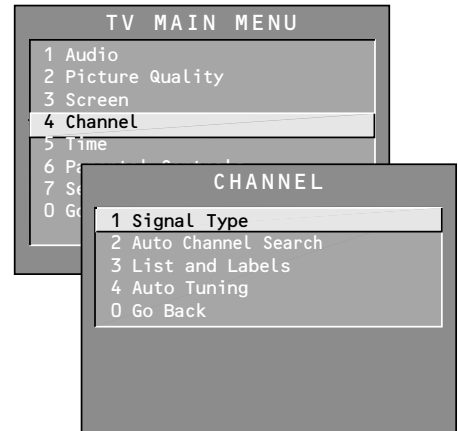

MENUS AND FEATURES

Not Connected Choose this if you do not have a component connected to an antenna or video input on the back of the monitor, or if you don't want the monitor to tune to a channel when the particular component button is pressed.

Channel 2 (DIRECTV only), 3 or 4 Choose this if your component is connected to the antenna jack on the back of the monitor, and you want the monitor to tune to channel 2 (DIRECTV/Cable only), 3 or 4 when you press the specified component button. Reminder: Make sure the component's Ch 2/3/4 switch is set to the corresponding channel.

Video 1, Video 2, Video 3, or Front Input Choose this if your component is connected to the INPUT 1, INPUT 2, INPUT 3 or Front Input jacks of the monitor and you want the monitor to tune to VID1, VID2, VID3 or FRNT input channel when you press the specified component button. (If you connect S-video cables, the channel marker displays SVID1, SVID2 or SVID3.)

Component Input (DVD only) Choose this if your DVD player is connected to the 3 component video jacks on the back of the monitor and you want the monitor to tune to component video input channel when you press the specified component button.

(S)VGA 2 Input Choose this if your component is connected to the (S)VGA 2 input on the back of the monitor and you want the monitor to tune to the (S)VGA 2 Input channel when you press the specified component button.

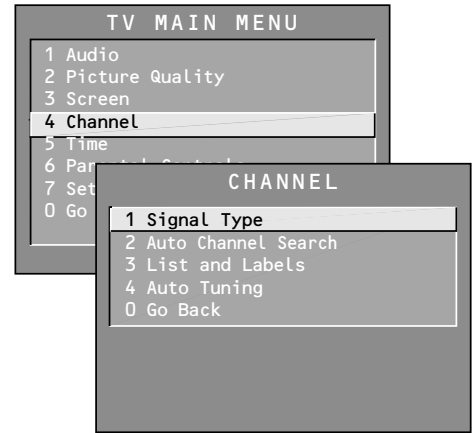

TIME MENU

Set Time Displays a control panel that lets you enter the current time. The on-screen directions guide you through the steps needed to set the time.

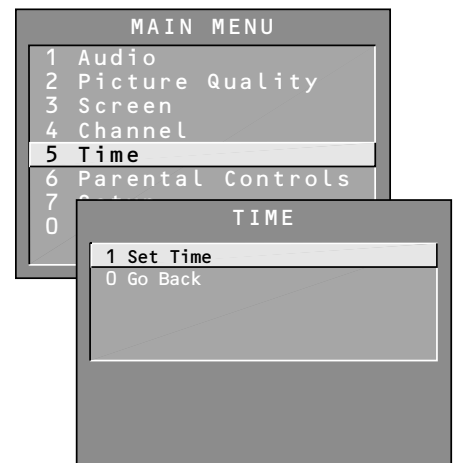

MENUS AND FEATURES

PARENTAL CONTROLS AND V-CHIP

The Parental Controls menu allows you to program your monitor so that children cannot see certain programs, channels, or use the front panel controls.

The first three choices in the Parental Controls menu involve a chip inside your monitor (called V-Chip) which allows you to “block” TV programs and movies based on violence, sex, or other content you may believe children should not view. In other words, it lets you program your monitor so it will not display certain programs. Once you block programs, you or other adults are not limited to only parent-approved programs; you can “unblock” programs by entering a password.

The V-Chip inside your TV comes turned “off,” so if you choose not to implement it, you can just ignore it.

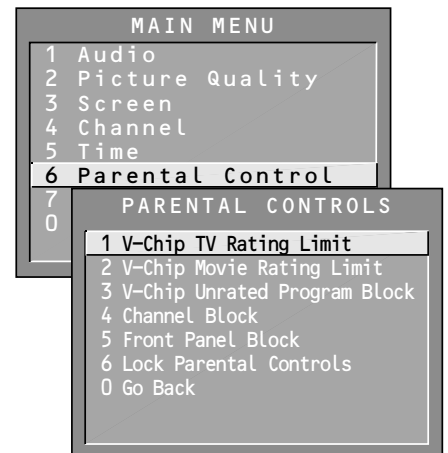

When turned “on,” the V-chip reads a code that most broadcasters send with programs. That code tells the V-Chip the program’s age-based rating (TV-MA, TV-14, etc.) and content themes (Violence (V), Adult Language (L), etc.). If you have blocked the rating and/or content themes that the program contains, you will receive the message, “This channel is not approved for viewing,” when you turn to that particular channel. Broadcasters are not required to provide content themes, so programs received with no content themes will only be blocked if you block their age-based rating. You can also block out programs that have been given a rating of “Not Rated”, and programs that are considered “unrated” because no code has been sent by the broadcaster.

The TV age-based ratings and content themes you can block are listed in the table below.

Age-Based Rating	Description and Content Themes for Age-Based Ratings
TV-MA	Mature Audience Only. Specifically designed to be viewed by adults and may be unsuitable for children under 17. It contains one or more of the following content themes: graphic violence (V), explicit sexual activity (S), or crude indecent language (L).
TV-14	Parents Strongly Cautioned. Contains some material that many parents would find unsuitable for children under 14. Parents are strongly urged to exercise greater care in monitoring this program and are cautioned against letting children under the age of 14 watch unattended. This program contains one or more of the following content themes: intense violence (V), intense sexual situations (S), strong coarse language (L), or intensely suggestive dialogue (D).
TV-PG	Parental Guidance Suggested. Contains material that parents may find unsuitable for younger children. Many parents may want to watch it with their younger children. The program contains one or more of the following content themes: moderate violence (V), some sexual situations (S), infrequent coarse language (L), or some suggestive dialogue (D).
TV-G	General Audience. Most parents would find this program suitable for all ages.
TV-Y7	Directed to Children 7 years and older. Designed for children ages 7 and above. It may be more appropriate for children who have acquired the developmental skills needed to distinguish between make-believe and reality. Themes and elements in this program may include mild fantasy violence (FV) or comedic violence, or may frighten children under the age of 7.
TV-Y	All Children. Themes and elements in this program are designed for a young audience, including children from ages 2-6. It is not expected to frighten younger children.

MENUS AND FEATURES

V-CHIP TV RATING LIMIT

The V-Chip TV Rating Limit lets you decide what TV programs can and cannot be viewed.

To set TV programming limits:

1. Choose *Parental Controls* from the Main menu. If Parental Controls have previously been locked, you must enter your password. If they are not locked, you will get a message reminding you that your limits will not be effective until you lock Parental Controls.
2. Press MENU to continue.
3. Highlight and select *V-Chip TV Rating Limit*.
4. Once you get to the V-Chip TV Rating Limit screen, use the arrows and OK on your remote to change the status of a TV program rating or content theme from *View* to *Block*.

The following sections give you more details about how to change the status of TV program limits.

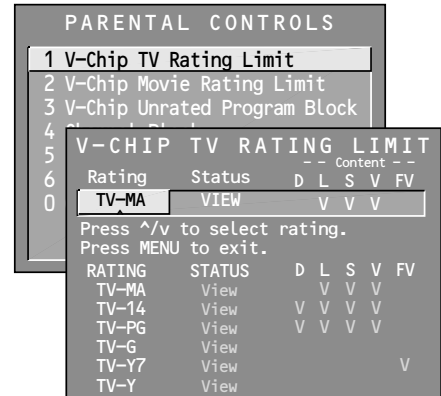

The Ratings Limits Screen

Below is an example of where items are located within the Rating Limits screen.

Rating Field

Lets you select from a list of age-based ratings you can block or view.

Rating Status Field

Lets you select whether the status of the age-based rating limit to the left is View or Block.

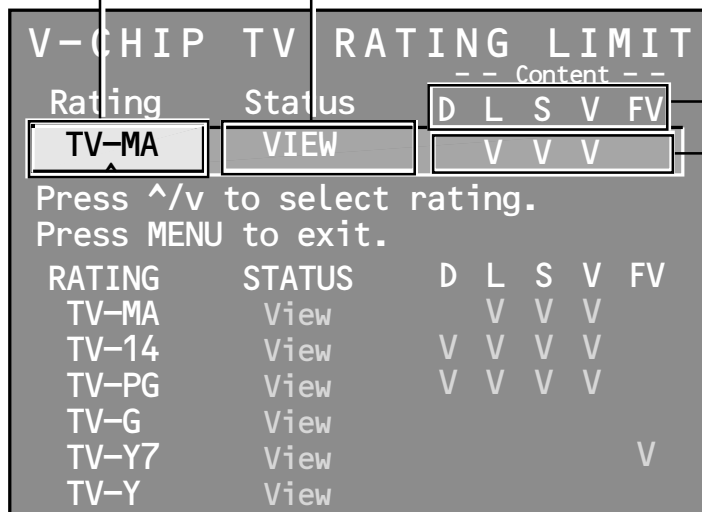

Content Themes

Lists the content themes you can block or view.

Content Status Fields

Lets you select which content themes to view for the selected rating, and whether the status of the content theme is currently View (V) or Block (B).

MENUS AND FEATURES

Blocking Age-Based Ratings

You can automatically block all program ratings above a specified age-based rating level. For example, if you only want your child to watch programs that have a TV-G rating and lower (in other words, you want the child to watch TV-G, TV-Y7, and TV-Y), then you need to block out other programming with higher ratings.

To block programs with higher ratings:

1. First, determine the lowest level rating you do not want the child to watch.
2. Use the left and right arrows to highlight the Rating Field.
3. Use the up and down arrows on the remote to scroll through the age-based rating limits. Keep scrolling until the rating corresponding with the lowest rating you do not want the child to watch appears.

In the example discussed above, you would scroll through the rating field until TV-PG appears, since the highest rating you want the child to watch is TV-G.

4. Use the right arrow to move the yellow highlight to the rating status field.
5. Press the up or down arrow to toggle between *View* and *Block*. The status for the rating listed to the left and all higher ratings automatically changes to *Block* (and *B*).

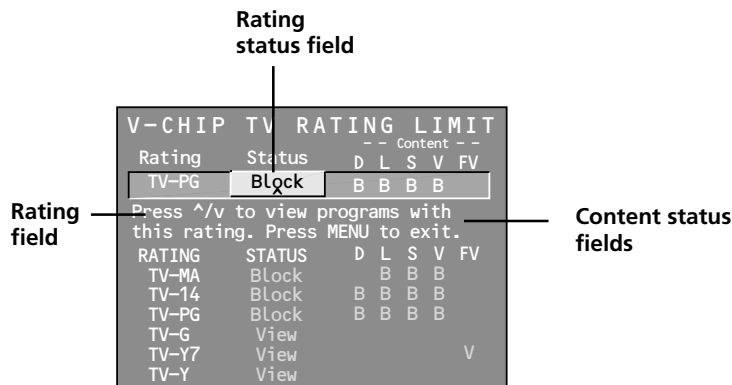

6. Press MENU or OK on the remote to return to the menu or exit the screen when you are finished.
7. Select Lock Parental Controls from the Parental Controls menu. Enter a password, and if you have not already set your password, you will be prompted to enter it again to confirm.

When you change the status of a rating to *Block*, the system will automatically block higher ratings and all corresponding content themes.

Hierarchy of Age-Based Ratings

TV-MA	Mature Audience Only
TV-14	Parents Strongly Cautioned
TV-PG	Parental Guidance Suggested
TV-G	General Audience
TV-Y7	Directed to Children 7 year and older
TV-Y	All Children

MENUS AND FEATURES

Viewing Age-Based Ratings

After you block age-based ratings, you have the option of changing some of the ratings back to *View*.

1. Determine which blocked rating you want to view.
2. Use the left and right arrows to highlight the Rating Field.
3. Use the up and down arrows to select the rating whose status is *Block*.
4. Press the right arrow to move the yellow highlight to the rating status field.
5. Press the up or down arrows to toggle between *View* and *Block*.

Note that the content status fields corresponding to the unblocked rating become *View* as well. They and the age-based rating status are the only fields that automatically change back to *View* when you complete this process.

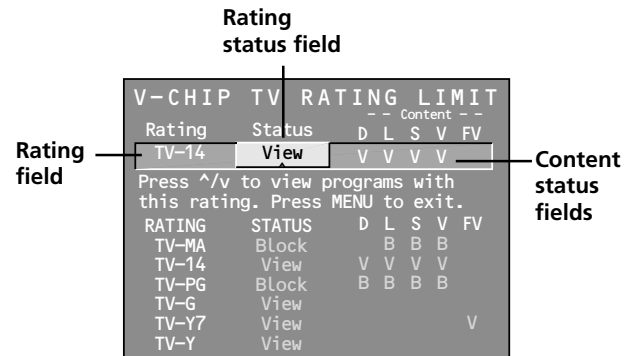

You must remember to Lock Parental Controls for rating limits to take effect.

Blocking Specific Content Themes

You can block programs based on their content. (Content is represented by the D, L, S, V, and FV on your screen. See the beginning of this section for details.) When you block a content theme for a particular rating, you automatically block that content theme for higher rated programs as well.

For example, if you do not want your child to watch programs that have adult language (L) rated TV-PG or higher, then you could block out all programming TV-PG and above containing adult language.

To block program content:

1. Determine the lowest level of content you do not want the child to watch.
2. Use the left and right arrows to highlight the Rating Field.
3. Use the up and down arrows on the remote to scroll through the age-based ratings until the rating that corresponds with the lowest content you do not want the child to watch appears. (In the example above, you would scroll through the ratings until the TV-PG rating appeared.)
4. Press the right arrow to move the highlight to the field corresponding with the content theme you wish to block out.
5. Press the up or down arrow to change content status from *V* to *B*. All higher ratings' content theme will automatically change to *B*.

Content Themes	
D	Sexually Explicit Dialogue
L	Adult Language
S	Sexual Situations
V	Violence
FV	Fantasy Violence

MENUS AND FEATURES

You must remember to Lock Parental Controls for rating limits to take effect.

Rating status field

V-CHIP	TV	RATING	LIMIT	
Rating	Status	D	L	S V FV
TV-PG	View	V	B	V V

Rating field

Content themes

Content status fields

Press ^/v to view programs with this content for this rating.

RATING	STATUS	D	L	S	V	FV
TV-MA	View		B	V	V	
TV-14	View	V	B	V	V	
TV-PG	View	V	B	V	V	
TV-G	View					
TV-Y7	View					V
TV-Y	View					

6. Press MENU or OK to return to the menu or exit the screen.

Viewing Specific Content Themes

If you block specific content themes, you have the option of going back and changing some of the content themes back to View (V):

1. Determine the content themes you want to change to View (V).
2. Use the left and right arrows to highlight the Rating Field.
3. Use the up and down arrows to scroll through the age-based ratings until the rating whose content theme you want to change to *View* appears.
4. Press the right arrow to move the yellow highlight to a particular content theme status, such as the *B* under language (L) corresponding with TV-14.
5. Press the up or down arrows to change its status back to *V*. Your child would then be able to watch programs with TV-14 adult language content, but not programs with TV-PG or TV-MA language content.

Rating status field

V-CHIP	TV	RATING	LIMIT	
Rating	Status	D	L	S V FV
TV-14	View	V	V	V V

Rating field

Content themes

Content status fields

Press ^/v to view programs with this content for this rating.

RATING	STATUS	D	L	S	V	FV
TV-MA	View		B	V	V	
TV-14	View	V	V	V	V	
TV-PG	View	V	B	V	V	
TV-G	View					
TV-Y7	View					V
TV-Y	View					

Note that only the content theme status corresponding to TV-14 language (L) changes to View (V). Higher rated content themes, such as that for TV-MA language, do not change.

MENUS AND FEATURES

V-CHIP MOVIE RATING LIMIT

You set movie rating limits by blocking movies rated above a specified level.

Blocking Movie Ratings

If you only want your child to watch movies that have a PG rating and lower (in other words, movies rated PG and G), then you could automatically block out all other movies with higher ratings.

To block movies:

1. Highlight the rating field and press the up and down arrows to find the rating that is the lowest rating you do not want the child to watch. (In the example above, you would point to the rating status button corresponding to PG-13, since the highest rating you want the child to watch is PG.)
2. Use the right arrow to highlight the rating status field. Press OK to change the button from *View* to *Block*. All higher ratings' *View* buttons will automatically change to *Block*.

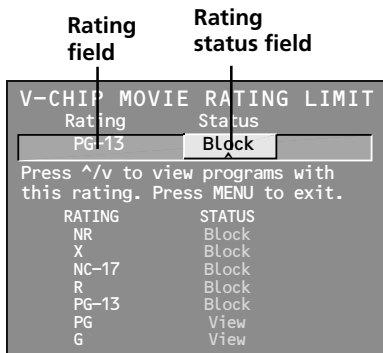

3. Press MENU or OK to return to the menu or exit the screen.
4. If Parental Controls are not locked, you must lock them so the movie rating limits will take effect. See the section *Locking Parental Controls*.

Viewing Movie Ratings

After you block movie ratings, you have the option of changing some of the rating status buttons back to View:

1. Highlight the rating field and press the up and down arrows to find the rating you want to view.
2. Use the right arrow to highlight the rating status field. Press the up and down arrows to change the button from *Block* to *View*.

For example, if movies with a rating of PG-13 and higher are blocked, you can change the rating status button corresponding with NC-17. Your child would then be able to watch all movies with a G, PG, and NC-17 rating.

3. Press the left arrow to return to the menu or exit the screen, and be sure parental controls are locked (see the section *Locking Parental Controls*).

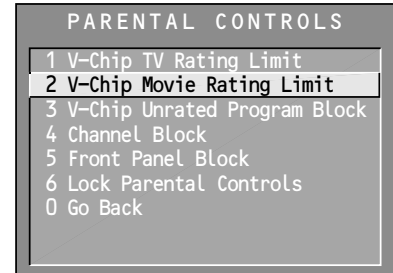

Some movies may be given a Not Rated (NR) rating. After blocking movie ratings, you must set NR to view separately to view NR movies.

You must remember to Lock Parental Controls for ratings limits to take effect.

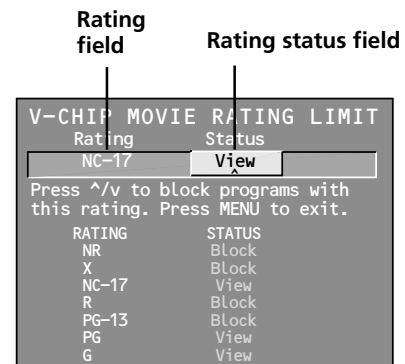

MENUS AND FEATURES

V-CHIP UNRATED PROGRAM BLOCK

Selecting this option lets you decide if programs that the V-Chip recognizes as “unrated” can be viewed. Note that “unrated” TV programs can include news, sports, political, religious, local, and weather programs, emergency bulletins, public announcements, and programs without a rating.

View All unrated programs are available.

Block All unrated programs are not available.

Don't forget to lock parental controls after you change the status of unrated program viewing. If you do not, the limit will not take effect.

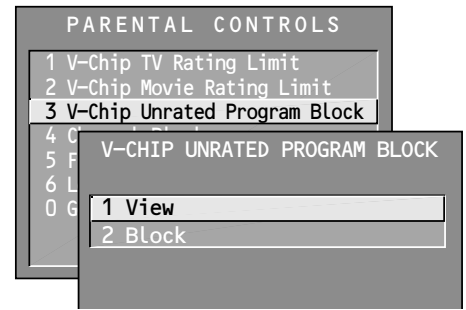

CHANNEL BLOCK

Selecting this option lets you decide what channels can be viewed.

View All channels are available.

Block The front panel CH (channel) buttons will tune only to channels that you have marked as *View*. The remote will still tune to the blocked channel if you use the digits to access the channel.

Don't forget to lock parental controls after you change the status of Channel Block. If you do not, the channel block will not take effect.

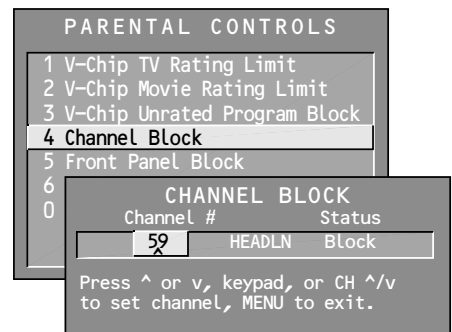

FRONT PANEL BLOCK

Selecting this option lets you block (disable) or unblock (enable) the monitor's front panel. The remote still tunes to any channel. Front Panel Block can:

- Keep children from watching TV when the parent is not present.
- Keep small children from playing with the buttons.

(When using this as a Parental Control method, you should remove access to any remote capable of controlling the monitor while you have the Front Panel blocked.)

Don't forget to lock parental controls after you change the status of Channel Block. If you do not, the channel block will not take effect.

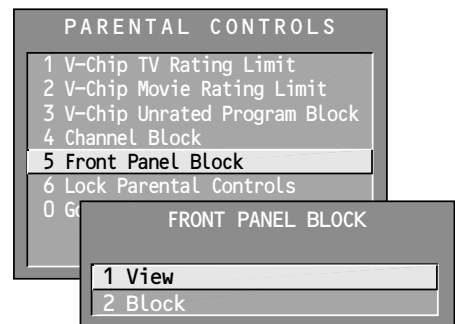

LOCK/UNLOCK PARENTAL CONTROLS

Selecting this option lets you lock and unlock parental controls settings using a password.

If you do not lock parental controls, none of the settings for V-Chip, Channel Block, or Front Panel Block will take effect.

If you forget your password, press and hold TV on the remote and the MENU button on the television simultaneously for 3 seconds. Parental controls will then unlock and you can re-enter a password via *Lock Parental Controls*.

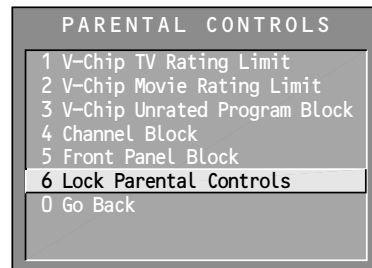

MENUS AND FEATURES

PIP (PICTURE-IN-PICTURE) OPERATION

The PIP (picture-in-picture) feature lets you display a second, smaller picture on top of the main picture.

Your monitor is equipped with a single tuner that tunes to cable or off-air television signals. The PIP feature on your monitor requires a second video source, like a VCR or satellite receiver to supply the second picture to the screen. The PIP feature also requires connecting the second video source to the monitor with audio/video cables.

PIP BUTTONS

There are four remote buttons that control the way the PIP window works:

PIP Brings up the PIP window. Press PIP again to remove the window. When PIP Caption Display – Alternate with PIP – has been selected, will display captioning in the PIP window.

MOVE buttons Let you move the PIP window to different areas of the screen.

SWAP Switches, or “swaps,” the video from the PIP window with the main picture.

CH CTRL (Channel Control) Lets you switch channel control between the PIP window and the main picture.

USING THE PIP FEATURE

While you may use PIP in different ways, this basic PIP scenario should get you started. While watching the TV, follow these steps to use your VCR to supply the picture for PIP.

1. Press the PIP button on the remote. The PIP window appears on the screen.
2. Turn on the VCR.
3. Press the TV button, then press WHO•INPUT until you see the VCR signal displayed in the PIP window. The PIP window should display the channel that you have the VCR tuned to.
4. At this point, in order to change the program in the PIP window, you need to change the channel on the VCR because that is the signal source for the PIP picture.
5. Use the channel up and down buttons and the other PIP buttons, MOVE, SWAP and CH CTRL to adjust the two pictures.

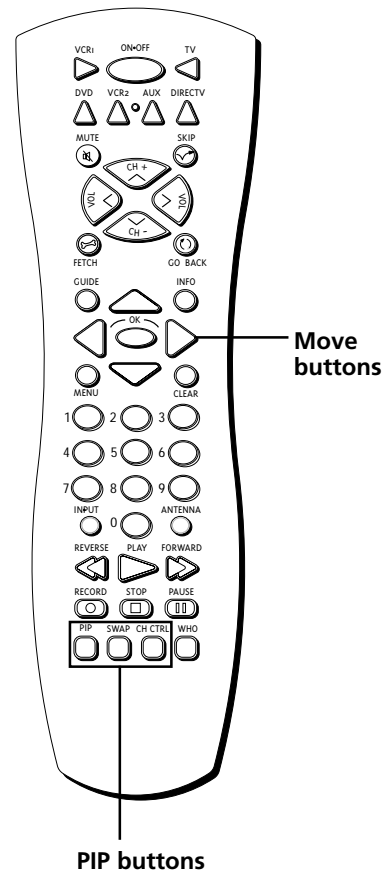

A typical use of SWAP is to scan through channels in the PIP window, and when you find a channel you like, press SWAP to display that channel in the main picture, sending the current channel to the PIP window.

You must change the mode between the TV and VCR after every SWAP.

MENUS AND FEATURES

PIP Problems?

- Make sure the remote is in the right mode. For example, once you turn on the VCR with the VCR1 button, you can't SWAP the pictures until you put the remote in TV mode. Just press the TV button.
- No signal or bad reception? Most VCRs and satellite receivers have an antenna or TV button. If your cable or off-air antenna goes into your VCR or satellite receiver, then into your monitor, try pressing the antenna or TV button on the front of the component.

Tip: If programmed to control your VCR, the ANTENNA button on the remote acts as a TV/VCR button.

- Check the connections. PIP requires a second video source, like a VCR or satellite receiver, connected to your monitor with audio/video cables. If you use a cable box, you may need extra equipment. Contact your cable company for more information.

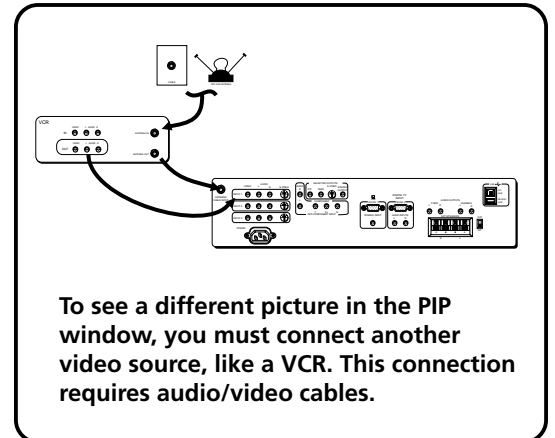

CHANNEL MARKER

There are several indicators that come up when you press the TV, INFO, PIP or SWAP button. This display is called the Channel Marker.

12:01 Displays the current time.

CC Displayed when Closed Captioning is available on the current channel.

VCR1 Displays the label assigned to the current channel.

VID1 Displays the current channel or input channel.

Mute (or Stereo) Mute is displayed when you mute the audio. Stereo is displayed when the current channel is broadcasting in Stereo.

PIP 59 (PIP Chan) Displays the current PIP channel.

00:00 Displayed to count down time left on the commercial skip (SKIP) timer.

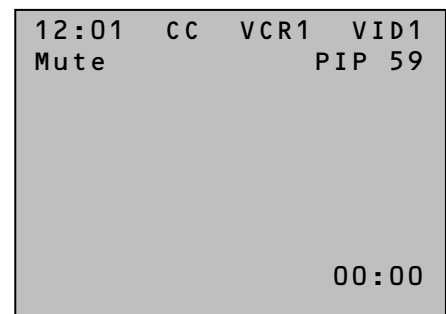

Sample displays on a Channel Marker

REFERENCE

GOOD INFORMATION TO KNOW

This section contains information that you don't have to know to use your monitor, but may want to refer to from time to time. It includes a specification sheet, some connection examples, a troubleshooting section, the limited warranty, an accessories order form and an index.

1 CONNECTIONS & SETUP



2 USING THE REMOTE



3 MENUS AND FEATURES



4 REFERENCE

REFERENCE

RCA MULTIMEDIA MONITOR SPECIFICATIONS

PICTURE	Optimum Contrast Screen	Yes	
	Picture Power (Watts)	65	
	Invar Shadow Mask	Yes	
	Stripe Pitch	0.78mm At Center	
	Dynamic Focus	Yes	
	Scan Velocity Modulation	Yes	
	Aperture Sharpness	Yes	
	Comb Filter	Digital 3 Line	
	Auto Color Control	Color Level & Tint	
	Auto Color Balance	Akb Gray Scale Tracking	
	Black Stretch	Yes	
	Color Detail Enhancement	Yes	
	Wide Band Video Amplifier	Yes	
	Video Noise Reduction	Yes	
	Calibrated Color Temperature	6500 & 9300 kelvin	
	MULTI-SYNC SCAN MODES	NTSC	15.75kHz / 30Hz Interlaced
		VGA Progressive	SVGA 800x600, 60Hz
HORIZONTAL RESOLUTION	Lines Per Picture Height	700	
	Lines Per Picture Width	950	
SOUND	Audio Power (Watts) Total	15 (7.5 Watts/Ch)	
	Dbx* Broadcast Stereo	Yes	
	Second Audio Program	Yes	
	Srs / Sound Retrieval System	Enhanced	
	Speakers	2 - 2.25" X 5" High Compliance	
CONVENIENCE	Channel Tuning Capability	181	
	Single tuner Picture-in-picture	Yes	
	Pip Swap And Move	Yes	
	Channel Labeling	Yes	
	Parental Control	Yes	
	Stereo Headphone Jack	3.5mm Stereo Mini-jack	
	Front A/V Input	Composite, L (Mono)/ Right	
	Universal Remote	Backlit	
	Plug & Play Compatibility	VESA DDC2b (Vga1)	
	Front Universal Serial Bus	2 - Hub	
	BACK PANEL INPUTS/OUTPUTS	Universal Serial Bus	Hub & Host
		A/V Inputs	3 - S-video / Composite
		Component Video Input	Y-pr-pb (RCA Jacks)
Monitor Control		VESA Ddc2b (Vga 1)	
Uhf/ Vhf, Cable Input		75-ohm Terminal	
Vga & Svga Inputs		2 - 15 Pin D-sub	
Selected A / V Outputs		S-video, Composite, L / R, Pip	
Computer Audio Input Jack		3.5mm Stereo Mini-jack (Vga1)	
Audio Output Jacks		Fixed And Variable	
External Speaker Terminals	Yes		
GENERAL SPECIFICATIONS		MM36100	
	Screen Size (Measured Diagonally)	36"	
	Dimensions (H X W X D)	30 X 33.5 X 24	

* dbx is a registered trademark of Carillon Electronics Corporation.

REFERENCE

TROUBLESHOOTING

Troubles sometimes are caused by simple “faults” that you can correct without the help of a service technician. If you experience any difficulty with your monitor, check a few basic remedies before calling your service technician.

Monitor will not turn on

- Check to make sure it is plugged in.
- Check the wall receptacle (or extension cord) to make sure it is “live” by plugging in something else.
- Maybe batteries in remote control are “dead.”
- Maybe remote control is not aimed at remote sensor.
- The front panel controls may be locked (disabled). Use the remote control to unlock the front panel controls by selecting the *Front Panel Lockout* in the Parental Controls menu and choosing *Unlock*.

Controls don't work

- If using remote control, make sure remote is in TV mode by first pressing TV button.
- The front panel MENU button may be disabled. Use the remote control to turn off channel blocking. Select *Channel Block* in the Parental Controls menu and choose *Off*.
- Try unplugging monitor for two minutes and then plug it back in and turn it on again.

Problems with Remote

- Maybe something is between the remote and the remote sensor.
- Maybe the remote is not aimed directly at the component (monitor, DVD player, VCR) you are trying to control.
- Maybe remote is not in TV Mode. Press the TV button so remote will control monitor.
- Maybe batteries in remote are weak, dead or installed incorrectly. Try replacing batteries. (Note, if you remove the batteries, you may have reprogram the remote to control other components.)
- Remove batteries and hold number 1 for at least 60 seconds to drain the microprocessor inside the remote. Release number 1, replace the batteries, and (if necessary) reprogram the remote.

Blank screen

- Maybe the component connected to the input jacks is not turned on.
- Try another channel.
- If you have connected a digital set top converter, you must connect to both the (S)VGA2 and INPUT2 inputs in order to view both digital and analog signals.

Picture on screen is not centered

- Adjust picture by going to Picture Position in the Screen Menu. Use remote arrows to adjust the horizontal and vertical position of the main picture window.
- Display properties may not be set correctly. Consult your computer operating system's owner's manual on how to adjust the display properties.

Horizontal or diagonal lines on screen

- The computer and monitor may not be synchronized properly. To set the correct resolution for your monitor you should consult your operating system's owner's manual on how to “boot” your system up into the “safe mode” to automatically set the correct resolution required.

Black Box appears on the screen

- Captioning may be turned on. Check the Closed-Caption Display control panel in the Channel menu.

REFERENCE

No sound, picture okay

- Maybe sound is muted. Try pressing volume up button to restore sound.
- Maybe speakers are turned off. Check the Audio Output and Speakers control panel in the Audio menu.
- If using an S-VHS component, remember to also connect the component's L and R AUDIO OUT jacks to the TV's L and R INPUT jacks.

Can't select certain channel

- Channel may be blocked or not approved in the Parental Controls menu.
- If using a VCR, check to make sure the TV/VCR switch on the VCR is in the correct position.

Turns off while playing

- Schedule off function may have been activated (parental control).
- Electronic protection circuit may have been activated because of a power surge. Wait 30 seconds and then turn on again. If this happens frequently, the voltage in your house may be abnormally high or low.

Noisy stereo reception

- May be a weak station. Use Audio menu to choose *mono* sound.

No picture, no sound but TV is on

- Maybe the cable/air function is set to the wrong position.
- Maybe a vacant channel is tuned.
- If watching VCR (connected only through antenna input), make sure TV is tuned to channel 3 or 4 – same as CH3/4 switch on VCR. Also check to make sure TV/VCR switch on VCR is in correct position.

Sound okay, picture poor

- Check antenna connections.
- Try adjusting sharpness function to improve weak signals.

CARE AND CLEANING

CAUTION: Turn OFF your monitor before cleaning.

You can clean the monitor as required, using a soft lint-free cloth. Be sure to occasionally dust the ventilation slots in the cabinet to help assure adequate ventilation.

The monitor's screen may be cleaned with a soft, lint-free cloth as well. Take care not to scratch or mar the screen. If necessary, you may use a cloth dampened with warm water.

Never use strong cleaning agents, such as ammonia-based cleaners, or abrasive powder. These types of cleaners will damage the monitor.

While cleaning do not spray liquid directly on the screen, or allow liquid to run down the screen and inside the monitor. Also, avoid placing drinks or vases with water on top of the monitor. This could increase the risk of fire or shock hazard or damage to the monitor.

Caution: If fixed (non-moving) images are left on the screen for long periods, they may be permanently imprinted on the screen. Such images include network logos, phone numbers, and video games. This damage is not covered by your warranty. Extended viewing of channels displaying these images should be avoided.

REFERENCE

RCA MULTIMEDIA MONITOR LIMITED WARRANTY

What your warranty covers:

- Any defect in materials or workmanship.

For how long after your purchase:

- One year for labor charges.
- One year for parts.
- Two years for the picture tube.

The warranty period for rental units begins with the first rental or 45 days from date of shipment to the rental firm, whichever comes first.

What we will do:

- Pay any Authorized RCA Digital Television Service Center the labor charges to repair your monitor.
- Pay any Authorized RCA Digital Television Service Center for the new or, at our option, refurbished replacement parts and picture tube required to repair your television.

How you get service:

- Call 1-888-901-HDTV and have your unit's date of purchase and model number ready.
- A representative will troubleshoot your problem over the phone.
- If the representative determines that you should receive service they will provide you with name(s) of the closest Authorized RCA Digital Television Service Center(s).
- Contact the Service Center and arrange for home service.
- Show the Authorized Service Center Representative your sales receipt or other evidence of purchase date or first rental.

What your warranty *does not* cover:

- Customer instruction. (Your Owner's Manual clearly describes how to install, adjust, and operate your monitor. Any additional information should be obtained from your dealer.)
- Installation and related adjustments.
- Signal reception problems not caused by your monitor.
- Damage from misuse or neglect.
- Batteries.
- Images burnt onto the screen.
- A monitor that has been modified or incorporated into other products or used for institutional or other commercial purposes.
- Acts of God, such as but not limited to lightning damage.

Product Registration:

- Please complete and mail the Product Registration Card packed with your monitor. It will make it easier to contact you should it ever be necessary. The return of the card is not required for warranty coverage.

How State Law relates to this warranty:

- This warranty gives you specific legal rights and you also may have other rights that vary from state to state.

If you purchased your television outside the United States:

- This warranty does not apply. Contact your dealer for warranty information.

REFERENCE

Accessory Information

Antenna (or cable-TV) connections are made with either coaxial antenna cable or twin-lead cable. Coaxial cables are shielded so they are less susceptible to hum or interference from adjacent cables.

Most audio/video connections between components can

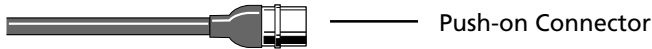

Push-on Connector

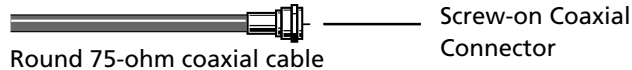

Round 75-ohm coaxial cable

Screw-on Coaxial Connector



Flat 300-ohm twin-lead cable

be made with shielded audio and video cables that have RCA-type phono connectors.



Standard Audio/Video cable with RCA-type phono plugs (such as No. VH83)

Color-Coded Jacks

The jacks on the TV's monitor panel are color-coded for ease of use. The video jacks are yellow, the right audio jacks are red, and the left audio jacks are white. When connecting components to each other, be sure that you always connect left outputs to left inputs and right outputs to right inputs.

To connect S-VHS (Super-VHS) components, an S-VHS video cable is required.



S-Video cable (such as No. VH913)

Gold-Plated Jacks and Gold-Tipped Cables

Gold plating helps prevent oxidation of contacts which provides much less loss than conventional contacts. A complete line of gold-tipped cables is available to help you obtain optimum performance from your equipment.

The following accessories are available from most dealers and electronics supply stores in case you want to position your components farther apart or need additional cables.

Antenna Cables



VH81 (3-ft)

VH82 (6-ft)

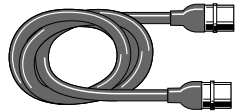

VH89 (6-ft)

Screw-on Cable attaches to the round antenna connectors (called 75-ohm F-type) on the back of your VCR or TV. The ends screw onto the connectors for a secure connection.

Push-on Cable attaches to the round antenna connectors (called 75-ohm F-type) on the back of your VCR or TV. Ends push on for a quick connection.

Audio/Video Cables

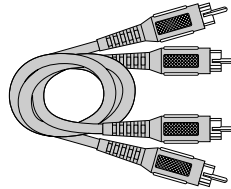

Gold-Tipped cable
VH83 (6-ft)

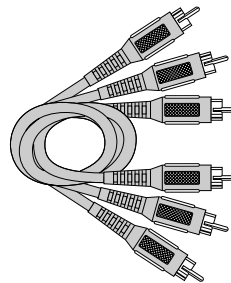

Gold-Tipped cable
AH84 (6-ft)

Monaural VCR Dubbing Cable
Double cable that lets you connect the video and audio jacks of two VHS VCRs to duplicate tapes. Can also be used to connect a VCR to your TV. Cable is color-coded and shielded. Has RCA-type phono plugs on each end.

Stereo VCR Dubbing Cable
Triple cable that lets you connect the VIDEO and AUDIO jacks of stereo components.

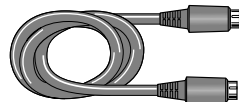

VH976 (6-ft)

VH913 (12-ft)

S-Video Cable has multi-pin connectors on each end for connecting S-Video components to your TV.

REFERENCE

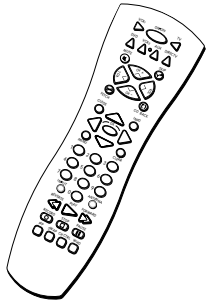

CRK76TCL2

Remote Control This is the remote control that came packed with your TV. Replacements or spares can be ordered as needed.

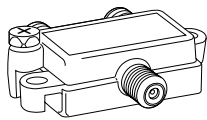

Splitter
VH47

2-way Signal Splitter helps you connect to a second TV or VCR.



ANT200

Amplified VHF/UHF/FM Antenna allows you to easily switch from the antenna signal to cable or satellite easily without disconnecting antenna.

SCTV 160

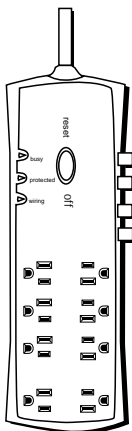

Surge Protector provides eight outlets, coaxial and telephone line protection. Audible alarm for surge failure.

Accessory Order Form

Description	Part No.	Price	Qty
Screw-on antenna cable (3-ft)	VH81	\$4.95	
Screw-on antenna cable (6-ft)	VH82	\$6.95	
Push-on antenna cable (6-ft)	VH89	\$5.95	
Monaural VCR Dubbing Cable (6-ft)	VH83	\$5.95	
Stereo VCR Dubbing Cable (6-ft)	VH84	\$9.95	
S-Video Cable (6-ft)	VH976	\$7.95	
S-Video Cable (12-ft)	VH913	\$8.95	
2-way Signal Splitter	VH47	\$3.95	
Amplified Antenna	ANT200	\$49.95	
Remote Control (CRK76TCL2)	240895	\$39.95	
Audio•Video Adapter	228449	\$4.35	
Surge Protector	SCTV160	\$49.95	

Prices are subject to change without notice.

Total Merchandise \$ _____

Sales Tax \$ _____

We are required by law to collect the appropriate sales tax for each individual state, country, and locality to which the merchandise is being sent.

Shipping and Handling \$ 5.00

Total Amount Enclosed \$ _____

Use VISA, MasterCard, or Discover Card preferably.

Money order or check must be in U.S. currency only.

No COD or CASH.



Detach Here

All accessories are subject to availability. Where applicable, we will ship a superseding model.

Please complete other side also

REFERENCE

Charge your order on your VISA, MasterCard, or Discover Card by filling in below

USE YOUR CREDIT CARD

IMPORTANT: Copy complete account number from your VISA card



□	□	□	□	□	□	□	□	□	□	□	□	□	□	□	□
---	---	---	---	---	---	---	---	---	---	---	---	---	---	---	---

My card expires:

□	□
---	---

□	□
---	---

IMPORTANT: Copy complete account number from your MasterCard



□	□	□	□	□	□	□	□	□	□	□	□	□	□	□	□	□	□	□	□
---	---	---	---	---	---	---	---	---	---	---	---	---	---	---	---	---	---	---	---

Copy Number above your name on MasterCard

□	□	□	□
---	---	---	---

 My card expires:

□	□
---	---

□	□
---	---

IMPORTANT: Copy complete account number from your Discover Card



□	□	□	□	□	□	□	□	□	□	□	□	□	□	□	□	□	□	□	□
---	---	---	---	---	---	---	---	---	---	---	---	---	---	---	---	---	---	---	---

My card expires:

□	□
---	---

□	□
---	---

AUTHORIZED SIGNATURE
 (Credit card order will not be processed without signature)
 Prices are subject to change without notice.

Print or type your name and address clearly. This will be your mailing label.



A complete and correct order will save you days of waiting.

Name: _____

Street: _____

_____ Apt: _____

City: _____

State: _____ Zip: _____

Please make sure that both sides of this form have been filled out completely.

- Allow 4 weeks for delivery.
- All accessories are subject to availability.
- Prices are subject to change

United States and Canada Orders

To place your order by phone, have your Visa, MasterCard or Discover Card ready and call the toll-free number listed below between 8AM and 8PM (EST) Monday through Friday or between 9AM and 5PM (EST) Saturday.

Use this number only to place on order for accessory items listed on this order form.

1-800-338-0376

To place your order by mail, detach and mail the completed order form with credit card information, money order or check in US currency (made payable to Thomson Consumer Electronics, Inc.) to the following address:

Video Accessories
PO Box 8419
Ronks, PA 17573

REFERENCE

RADIO INTERFERENCE

This equipment has been type tested and found to comply with the limits for a Class B Digital Device in accordance with the specifications in Part 15 of FCC Rules. These rules are designed to provide reasonable protection against radio and television interference in a residential installation. This equipment generates, uses and can radiate radio frequency energy and, if not installed and used in accordance with the instructions, may cause harmful interference to radio communications. However, there is no guarantee that interference will not occur in a particular installation.

If this equipment does cause interference to radio or television reception (which you can determine by turning the equipment off and on), try to correct the interference by one or more of the following measures:

- Reorient or relocate the receiving antenna (that is, the antenna for radio or television that is “receiving” the interference).
- Change the position of the multimedia monitor with respect to the radio or television equipment that is receiving interference.
- Move the multimedia monitor away from equipment receiving interference.
- Plug the multimedia monitor into a different wall outlet so the receiver and equipment receiving interference are on different branch circuits.

If these measures do not eliminate interference, please consult your dealer or an experienced radio/television technician for additional suggestions. Also, the Federal Communications Commission has prepared a helpful booklet, “How To Identify and Resolve Radio/TV Interference Problems”. This booklet is available from the U.S. Government Printing Office, Washington, D.C. 20402. Please specify stock number 004-000-00345-4 when ordering copies.

INDEX

A

- Accessories 56
- Antenna/Cable In jack 6
- Audio Menu
 - Audio Processor 36
 - Mute 36
 - Sound Logic Stereo 36
 - Speakers 36
 - Tone Controls 36
 - Mono 36
 - Second Audio Program 36
 - SRS Stereo 36
 - Stereo 36
- Audio menu 36
- Audio Output 9
- Audio Processor 36
- Audio remote codes 32
- Audio/Video Inputs 7
- Auto Channel Search 39
- Auto Color 37
- Auto Tuning 25, 39
 - DVD Channel 23
 - SAT/Cable Channel 24, 39
 - VCR1 Channel 21, 39
 - VCR2 Channel 22, 39
- Automatic Code Search 30

B

- Back Panel
 - A/V Inputs 7
- Basic Picture Controls 37
- Batteries 18, 49
- Black Level 37
- Buttons
 - Front panel 31
 - Remote 28

C

- Cable box remote codes 32
- Care and Cleaning 54
- CC 49
- Chan # 39
- Chan Labels 39
- Channel Block 47
- Channel Marker 49
- Channel menu 39
- Channels
 - DVD/VCR2 Channel 25

Closed Caption

- Display 38
- Mode 38
- coaxial cable 6
- Color Warmth 37
- Connecting Components 6
 - Computer 15
 - Digital Set Top Converter 16
- Connecting Optional Components
 - A/V Receiver 13
 - DVD Player 12
 - Satellite Receiver 11
 - Speakers 13
 - VCR 10
- Content Themes 41
- Contrast 37

D

- DDC2B 15
- DVD Channel 23

E

- Exiting a menu 34
- External Speakers 9

F

- Fixed images 54
- Front panel buttons 31
- Front Panel Inputs 17
- Front Panel Lockout 47

I

- Input button 29
- INPUT1 40

L

- Labels 25, 39
- Limited Warranty 55

M

- Menus 34
 - Choice Lists 36
 - Control Panels 35
 - exiting 34
 - Numeric entry 35
 - Sliders 35
- Mono 36
- Mute 36

P

Parental Controls

- Channel Block 47
- Channel block 47
- Front Panel Block 47
- Front Panel Lockout 47
- Locking, unlocking 47
- Menu 41
- Parental Controls menu 41
- Picture Position 38
- Picture Presets 37
- Picture Quality Menu 37
 - Black Level 37
 - Color 37
 - Contrast 37
 - Sharpness 37
 - Tint 37

Picture Size 38

Picture Tilt 38

PIP (Picture in Picture)

- Buttons 48
- PIP Chan 49
- Problems 49
- Using 48
- Programming the Remote
 - Automatic code search 30
 - Testing the remot 29

R

Rating Limits

- Movie 46
- TV 42
- RCA cable 7
- Remote Control
 - Installing the batteries 18
 - Programming 29
 - Remote batteries are low 49

Remote control

- Buttons 28

S

- S-Video cable 7
- S-Video Input 7
- SAT/Cable Channel 24, 39
- Satellite Receiver remote codes 32
- Second Audio Program (SAP) 36
- Selected Video Outputs 8
 - MAIN 8
 - PIP 8

INDEX

S-Video 8

Stereo Output 8

Set

DVD Channel 23

DVD/VCR2 Channel 25

SAT/CABLE Channel 24, 39

VCR1 Channel 21, 39

VCR2 Channel 22, 39

Set Time 40

Sharpness 37

Signal Type

Cable TV 39

UHF/VHF Antenna 39

Sleep Timer 40

Stereo 36, 49

T

Time

Current 49

Time, setting 19

Tint 37

Tone Controls 36

Troubleshooting 53

U

USB Inputs/Output 17

V

V-Chip

Age-Based Ratings 41

Blocking Movies 46

Content themes 41

V-chip 41

VCR remote codes 32

VCR1 Channel 21, 39

VCR2 Channel 22, 39

VESA DPMS 15

Video Inputs

viewing 7, 8

Video Noise Reduction 37

Viewing Video Inputs 7, 8

 **THOMSON CONSUMER ELECTRONICS**
10330 North Meridian Street
Indianapolis, IN 46290

©1999 Thomson Consumer Electronics, Inc.
Trademark(s)® Registered
Marca(s) Registrada(s)
Printed in USA
TOCOM 15351800



100%
RECYCLED PAPER
MINIMUM 40% POST CONSUMER

